

[AT810 LCR Meter]
USER'S GUIDE

Safety Summary



When you notice any of the unusual conditions listed below, immediately terminate operation and disconnect the power cable.

Please Contact Applent Instruments Incorporation sales representative for repair of the instrument. If you continue to operate without repairing the instrument, there is a potential fire or shock hazard for operators.

Instrument operates abnormally.

Instrument emits abnormal noise, smell, smoke, or a spark-like light during the operation.

Instrument generates high temperature or electrical shock during operation.

Power cable, plug, or receptacle on instrument is damaged.

Foreign substance or liquid has fallen into the instrument.

Safety Summary



The following general safety precautions must be observed during all phases of operation, service, and repair of this instrument. Failure to comply with these precautions or with specific WARNINGS elsewhere in this manual may impair the protection provided by the equipment. In addition it violates safety standards of design, manufacture, and intended use of the instrument.

Disclaimer *The Applent Instruments assumes no liability for the customer's failure to comply with these requirements.*

Ground
The Instrument To avoid electric shock hazard, the instrument chassis and cabinet must be connected to a safety earth ground by the supplied power cable with earth blade.

DO NOT
Operate In An Explosive
Atmosphere Do not operate the instrument in the presence of inflammable gasses or fumes. Operation of any electrical instrument in such an environment constitutes a definite safety hazard.

Keep Away
From Live
Circuits Operating personnel must not remove instrument covers. Component replacement and internal adjustments must be made by qualified maintenance personnel. Do not replace components with the power cable connected. Under certain conditions, dangerous voltages may exist even with the power cable removed. To avoid injuries, always disconnect power and discharge circuits before touching them.

DO NOT
Service Or Adjust Alone Do not attempt internal service or adjustment unless another person, capable of rendering first aid and resuscitation, is present.

DO NOT
Substitute Parts Or
Modify Instrument Because of the danger of introducing additional hazards, do not install substitute parts or perform unauthorized modifications to the instrument. Return the instrument to an Applent Instruments Sales and Service Office for service and repair to ensure that safety features are maintained.

AT810 LCR Meter

User's Guide

FIRMWARE REVISIONS

This manual applies directly to instruments that have the
firmware **Rev. E**

English

Rev. E 2010/10

Manual Print History

The print history shown below lists the printing dates of all Revisions and Addenda created for this manual. The Revision Level letter increases alphabetically as the manual undergoes subsequent updates. Addenda, which are released between Revisions, contain important change information that the user should incorporate immediately into the manual. Addenda are numbered sequentially. When a new Revision is created, all Addenda associated with the previous Revision of the manual are incorporated into the new Revision of the manual. Each new Revision includes a revised copy of this print history page.

Revision A January, 2005
Revision B January, 2010
Revision E OCT, 2010



©2005-2010 Applent Instruments, Inc.

CERTIFICATION, LIMITED WARRANTY, & LIMITATION OF LIABILITY

Applent Instruments, Inc. (shortened form **Applent**) certifies that this product met its published specifications at the time of shipment from the factory. Applent further certifies that its calibration measurements are traceable to the People's Republic of China National Institute of Standards and Technology, to the extent allowed by the Institution's calibration facility or by the calibration facilities of other International Standards Organization members.

This Applent instrument product is warranted against defects in material and workmanship for a period corresponding to the individual warranty periods of its component products. **The warranty period is 2 years and begins on the date of shipment.** During the warranty period, Applent will, at its option, either repair or replace products that prove to be defective. This warranty extends only to the original buyer or end-user customer of a Applent authorized reseller, and does not apply to fuses, disposable batteries or to any product which, in Applent's opinion, has been misused, altered, neglected or damaged by accident or abnormal conditions of operation or handling.

For warranty service or repair, this product must be returned to a service facility designated by Applent. The buyer shall prepay shipping charges to Applent and Applent shall pay shipping charges to return the product to the Buyer. However, the Buyer shall pay all shipping charges, duties, and taxes for products returned to Applent from another country.

Applent warrants that its software and firmware designated by Applent for use with an instrument will execute its programming instruction when properly installed on that instrument. Applent does not warrant that the operation of the instrument, or software, or firmware, will be uninterrupted or error free.

The foregoing warranty shall not apply to defects resulting from improper or inadequate maintenance by the Buyer, Buyer-supplied software or interfacing, unauthorized modification or misuse, operation outside the environmental specifications for the product, or improper site preparation or maintenance.

THIS WARRANTY IS BUYER'S SOLE AND EXCLUSIVE REMEDY AND IS IN LIEU OF ALL OTHER WARRANTIES, EXPRESS OR IMPLIED, INCLUDING BUT NOT LIMITED TO ANY IMPLIED WARRANTY OF MERCHANTABILITY OR FITNESS FOR A PARTICULAR PURPOSE. APPLMENT SHALL NOT BE LIABLE FOR ANY SPECIAL, INDIRECT, INCIDENTAL OR CONSEQUENTIAL DAMAGES OR LOSSES, INCLUDING LOSS OF DATA, WHETHER ARISING FROM BREACH OF WARRANTY OR BASED ON CONTRACT, TORT, RELIANCE OR ANY OTHER THEORY.

Applent Instruments, Inc.
Changzhou,
Jiangsu,
The People's Republic of China.
Rev.A2 January, 2005
Rev.B0 January, 2008

Contents

Safety Summary	2
Safety Summary	2
CERTIFICATION, LIMITED WARRANTY, & LIMITATION OF LIABILITY	4
Contents	5
Figure Contents.....	6
Table Contents	6
1. Unpacking and Preparation.....	7
1.1 Incoming Inspection	7
1.2 Setting up Fuse	7
1.3 Environmental Requirements	8
1.4 Cleaning.....	8
1.5 How to Remove the Handle.....	8
2. Overview	10
2.1 Introduction.....	10
2.2 Main Specifications	10
2.3 Feature Overview.....	10
3. Start up.....	12
3.1 Front Panel.....	12
3.1.1 Front Panel Summary	12
3.2 VFD	13
3.3 Keypad.....	13
3.4 Real Panel Summary.....	14
3.5 Power-up.....	14
3.5.1 Line Power Connection	14
3.5.2 Power-up Sequence.....	14
3.5.3 Power-up Defaults	14
3.5.4 Warm-up Time	14
4. Configuration.....	15
4.1 Connect to Device under Test (DUT)	15
4.2 Measurement Parameter [Param Key]	15
4.3 Test Frequency [Freq Key]	16
4.4 Setting the Sampling Rate [Rate Key]	16
4.5 Setting the Measurement Range [Auto Key]	16
4.6 Clear Zero [Clear ^(Shift) Key].....	16
4.7 Comparator [Comp ^(Shift) Key]	17
4.7.1 To setup comparator.....	17
4.7.2 How the comparator work	17
4.8 Monitor Parameter [View ^(Shift) Key]	18
4.9 Menu.....	18
4.9.1 Signal Voltage Level (LEVEL).....	19
4.9.2 Equivalent Circuit (EQU)	19
4.9.3 Source Output Impedance (SRES).....	21
4.9.4 Beep Set(BEEP).....	21
4.9.5 Trigger Set(TRIG)	21
4.9.6 Remote control (COM).....	22
5. Handler Interface	23
5.1 Pin Assignment	23
5.2 Power Rating	24
5.3 Electrical Characteristics	24
5.3.1 Input Signal:.....	24
5.3.2 Output Signal:.....	24
5.3.3 Power supply	24
5.4 Timing Chart.....	25
6. Specification	27
6.1 General Specification.....	27
6.2 Dimensions	28

Figure Contents

Figure 1-1	Fuse Holder.....	7
Figure 1-2	How to remove the handle.....	9
Figure 3-1	Front Panel.....	12
Figure 3-2	VFD.....	13
Figure 4-1	Connect to DUT.....	15
Figure 4-2	Workflow.....	17
Figure 4-3	The RS-232 connector in the real panel.....	22
Figure 5-1	Typical Circuit Diagram of Handler Interface Input signals.....	24
Figure 5-2	Typical Circuit Diagram of Handler Interface Output signals.....	24
Figure 5-3	Timing chart.....	25

Table Contents

Table 4-1	RS-232 connector pinout.....	22
Table 5-1	Pin assignment.....	23
Table 5-2	Output Signals.....	23
Table 5-3	Input Signals.....	24
Table 5-4	Power Signal.....	24
Table 5-5	Timing.....	26

1. Unpacking and Preparation



This chapter describes how to set up and start the AT810 LCR Meter.

- Incoming Inspection
- Power Requirements
- Setting up the Fuse
- How to Remove the Handle
- Environmental Requirements
- Cleaning

1.1 Incoming Inspection

After you receive the instrument, carry out checks during unpacking according to the following procedure.



If the external face of the instrument (such as the cover, front/rear panel, VFD screen, power switch, and port connectors) appears to have been damaged during transport, do not turn on the power switch. Otherwise, you may get an electrical shock.

Check that the packing box or shock-absorbing material used to package the instrument has not been damaged.

Referring to <Packing List> in the packing box, check that all packaged items supplied with the meter have been provided as per the specified optioned.

NOTE

If an abnormality is detected, contact the company and transport the meter to your nearest Applent Instruments sales or service office. For inspection by the transport company, save the packing box, shock-absorbing material, and packaged items as you received them.

1.2 Setting up Fuse

Figure 1-1 Fuse Holder

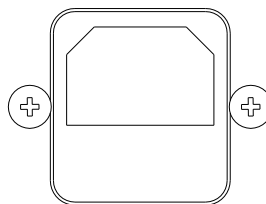

~Line: 198VAC–252VAC
30VA MAX
Fuse: 250V 1A
Slow Blow

Please use the following fuse type.

UL/CSA type, Slow-Blow, 5×20-mm miniature fuse, 1A, 250 V



When you need a fuse, contact your nearest Applent Instruments sales or service office. To verify and replace the fuse, remove the power cable and pull out the fuse holder.

NOTE Two fuses in Fuse Holder.

1.3 Environmental Requirements

Set up the AT810 where the following environmental requirements are satisfied.

Operating Environments

Ensure that the operating environment meets the following requirements.

Temperature: 0°C to 55°C

Temperature range at calibration: 23°C±5°C (<1°C deviation from the temperature when performing calibration)

Humidity: 15% to 85% at wet bulb temperature ≤ 40°C (non-condensation)

Altitude: 0 to 2,000m

Vibration: Max. 0.5 G, 5 Hz to 500 Hz

1.4 Cleaning

To prevent electrical shock, disconnect the AT810 power cable from the receptacle before cleaning.

Use a dry cloth or a cloth slightly dipped in water to clean the casing.

Do not attempt to clean the AT810 internally.



WARNING: Don't Use Organic Solvents (such as alcohol or gasoline) to clean the Instrument.

1.5 How to Remove the Handle

A handle kit is attached to the AT810:

Figure 1-2 How to remove the handle

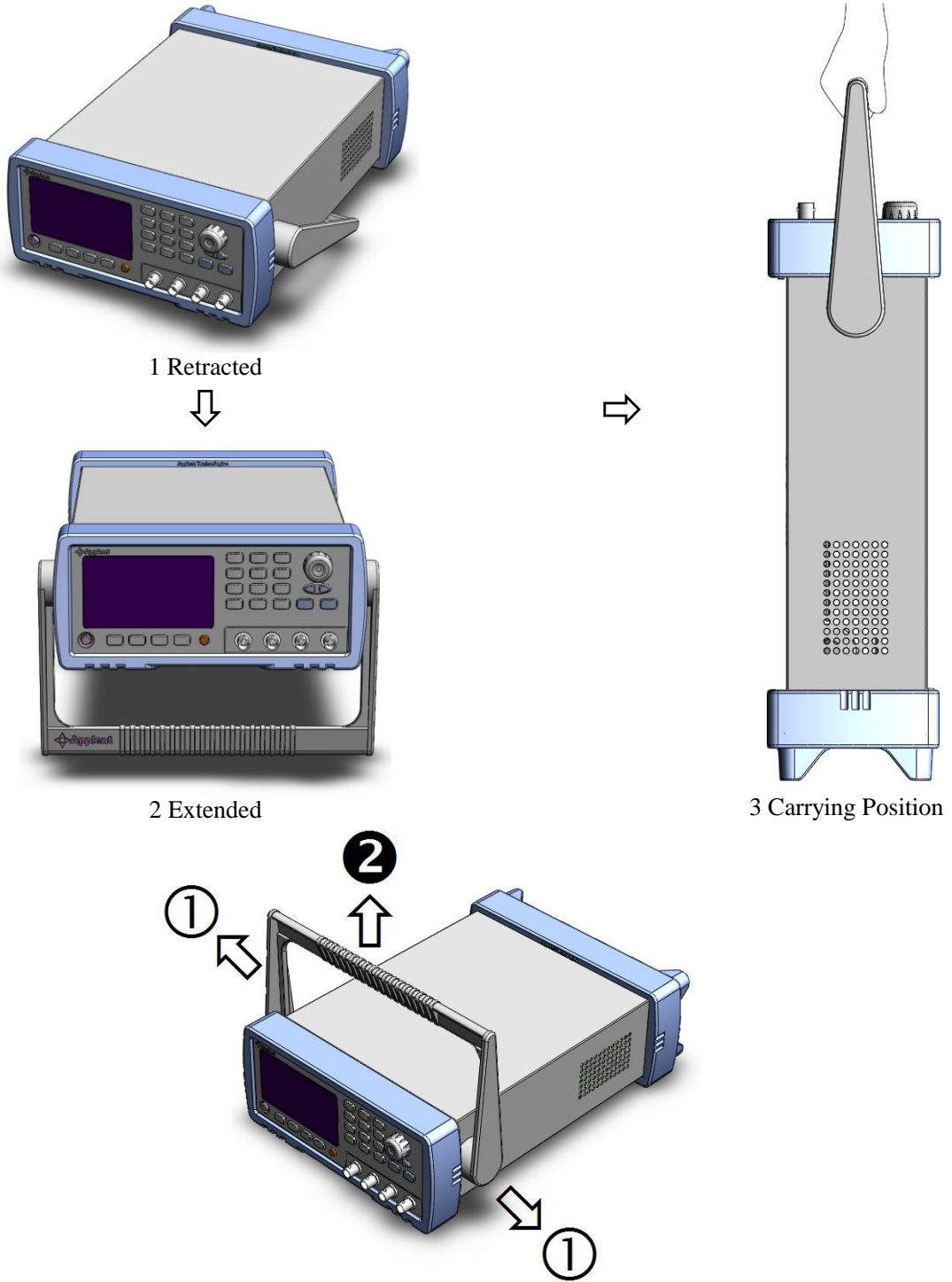

Remove Handle (Lift the handle perpendicular to the unit while pulling it in the direction of 1.)

2. Overview

This chapter contains general information about the AT810 LCR Meter. The information is organized as follows

- Introduction
 - Main Specifications
 - Feature overview
-

2.1 Introduction

Thank you for purchasing AT810 LCR Meter.

The Applent AT810 is a general-purpose LCR meter for incoming inspection of components, quality control, and laboratory use. The AT810 is used for evaluating LCR components, materials, and semiconductor devices.

The AT810 can output comparison/decision results for sorting components into 5 bins. Furthermore, by using the handler interface, AT810 can be easily combined with a component handler and a system controller to fully automate component testing, sorting, and quality-control data processing.

The RS-232 (used SCPI) and Handler interfaces are standard interfaces on the AT810 and enabled automatic testing.

2.2 Main Specifications

Some main specifications of the AT810 include:

Full specifications are included in Appendix A.

- Test Function: L-D, C-D, R-Q and Z-Q
- Test Signal Frequency: 100Hz, 120Hz, 1kHz, 10kHz
- Test Signal Level: 0.1V, 0.3V, 1V
- Basic Accuracy: 0.1%
- Equivalent Circuit: Serial and Parallel
- Automatic Test with 6 Ranges
- Measurement Speed: 25 readers per second
- Measurement Range:
 - L: 0.01 μ H-9999H
 - C: 0.01pF – 9999mF
 - R: 0.0000 Ω -999.99 Ω
 - Z: 0.0000 Ω -999.99 Ω
 - D: 0.0000-9999
 - Q: 0.0000-9999
- Trigger mode: Internal Trig, Manual (Remote) Trig and External (Handler) Trig.

2.3 Feature Overview

- High brightness VFD
window size: 98mm×58mm
- Correction (Zeroing) Function

-
- *Zero out test lead and fixture measurement errors.*
 - Built-in Comparator (Sorting)
5Bins: BIN1-BIN3, AUX and OUT.
 - Beep and VFD Brightness can be Adjusted
Setup Pass or Fail Beep and adjust VFD Brightness.
 - Interfaces
 1. Handler interface: BIN Output, Trig Signal Input and EOC (Busy) Output.
 2. RS232C interface: SCPI Compatibility, ASCII Transmission.

3. Start up

This chapter describes names and functions of the front panel, rear panel, and screen display and provides the basic procedures for operating the AT810.

- Front Panel Summary
- Real Panel Summary
- Power-up
- Begin Measuring

3.1 Front Panel

3.1.1 Front Panel Summary

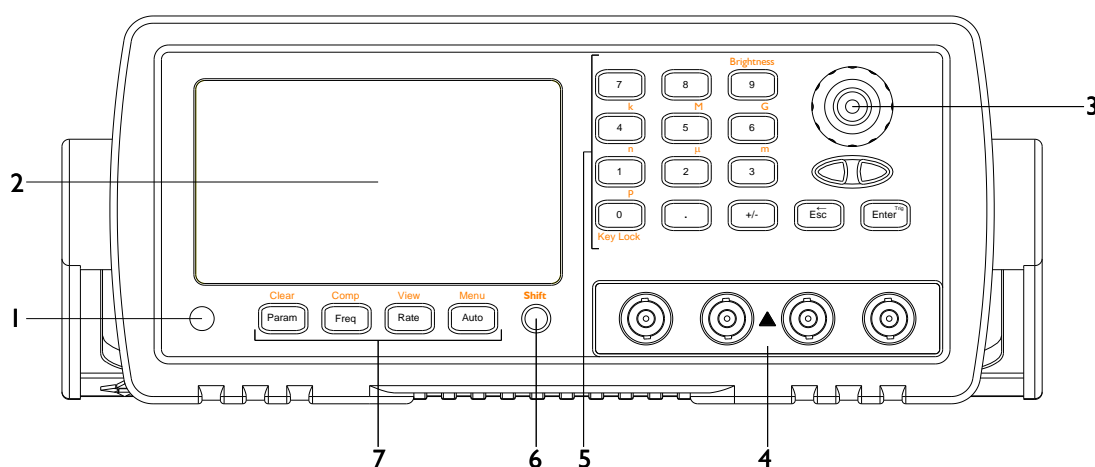

Figure 3-1 Front Panel

No.	Function
1	Power Switch <i>To apply power to the instrument, Push Down: ON, Push Up: OFF</i>
2	Display <i>VFD Screen, Displays measurement results, instrument status and user's interface menus.</i>
3	Knob <i>To Choose Menu Item and Input Number</i>
4	Terminals
5	Entry Enter numerical values
6	Shift Key
7	Main Function Keypad, <i>Includes [Param],[Freq],[Rate],[Auto], [Clear],[Comp],[View] and [Menu].</i>

3.2 VFD

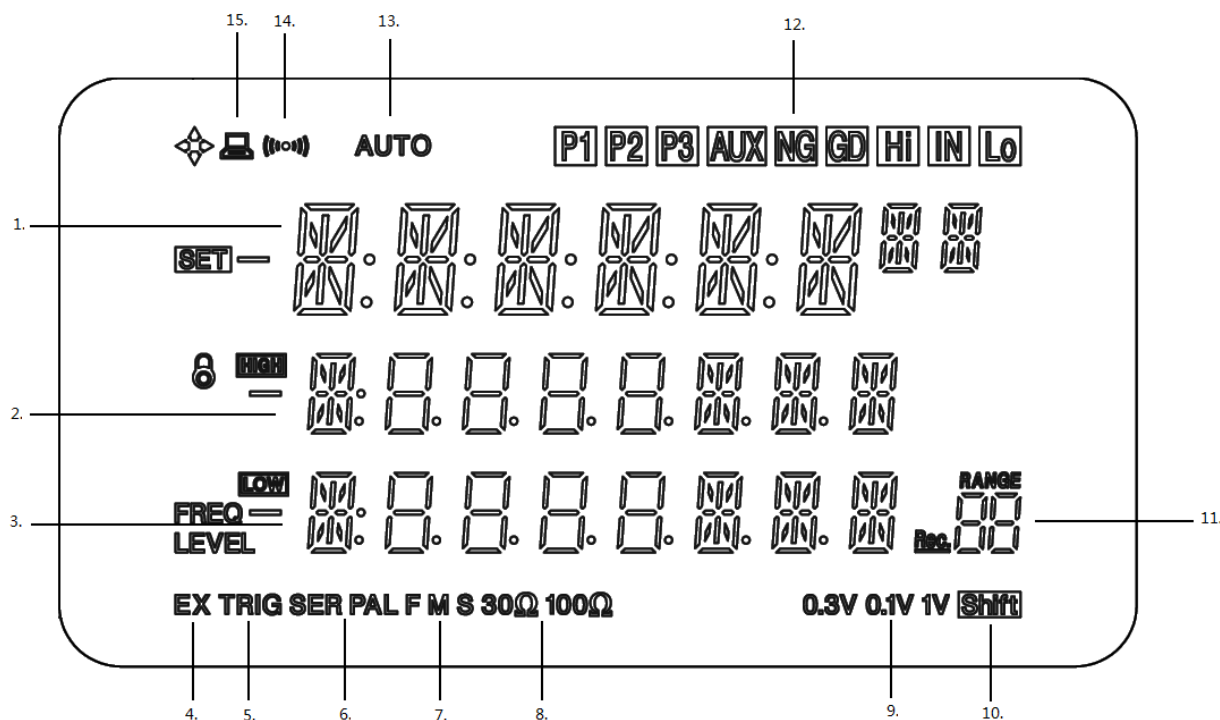

Figure 3-2 VFD

No	ICON	Function
(1)		No.1 Display Line.
(2)		No.2 Display Line
(3)		No.3 Display Line
(4)	EX TRIG	TRIG: Manual Trig , EX TRIG : External Trig
(5)	SER PAL	Equivalent Circuit: Serial and Parallel
(6)	FMS	Rate (Fast, Medium and Slow)
(7)	30Ω 100Ω	Signal Source Resistance
(8)	0.3V 0.1V 1V	Test Signal Level
(9)		
(11)	RANGE Rec. 00	Range No.
(12)		Comparator Result
(13)	AUTO	Range Auto
(14)	((00))	Beep On
(15)	Remote	Remote

3.3 Keypad

Keypad	Function
Param	Select Parameter: L-Q, C-D, R-Q, Z-Q
Freq	Setup Test Frequency: 100Hz, 120Hz, 1kHz, 10kHz
Rate	Setup Measurement Speed: F, M and S.
Auto	Auto Range Mode.
Clear	Perform Open/Short Correction.
COMP	Setup Comparator.
View	Display 3 rd Parameter on No.3 Line: <i>D, Q, Z , θ(deg), θ(rad), ΔABS, Δ% and Comparator Result.</i>
MENU	Menu. Enter Setup Menu.

3.4 Real Panel Summary

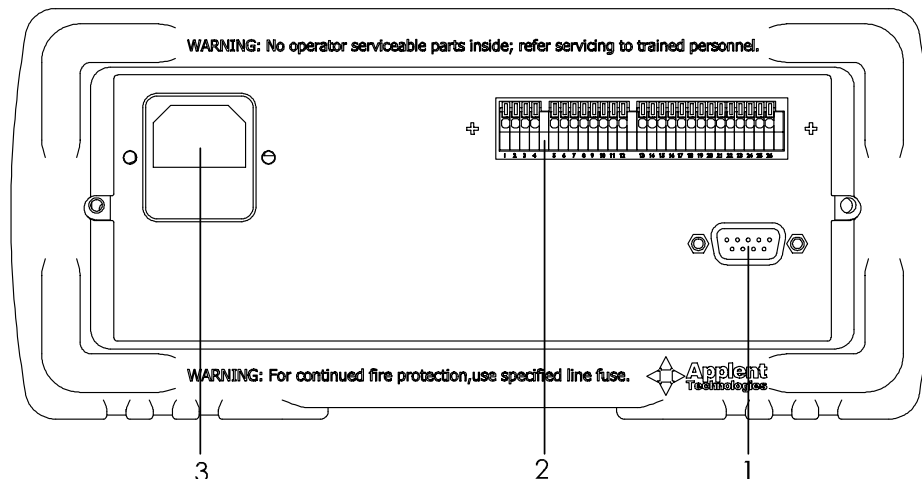

Figure 3-3 Real Panel

No	Function
1	RS-232 Interface
2	Handler Interface
3	AC Inlet Module

3.5 Power-up

3.5.1 Line Power Connection

Follow the procedure below to connect the AT810 to line power and turn on the instrument.

1. Before plugging in the power cord, make sure that the front panel power switch is in the off (0) position.
2. Connect the female end of the supplied power cord to the AC receptacle on the rear panel. Connect the other end of the power cord to a grounded AC outlet.



WARNING :

The power cord supplied with the AT810 contains a separate ground wire for use with grounded outlets. When proper connections are made, instrument chassis is connected to power line ground through the ground wire in the power cord. Failure to use a grounded outlet may result in personal injury or death due to electric shock..

3. Turn on the instrument by pressing the front panel power switch to the on (1) position.

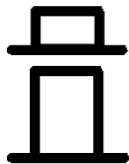

Power On



Power Off

3.5.2 Power-up Sequence

On power-up, AT810 performs self-tests on its FlashRom and RAM and momentarily lights all segments. If a failure is detected, the instrument will not enter the measurement state.

3.5.3 Power-up Defaults

The power-on default will be the last configuration you saved.

3.5.4 Warm-up Time

AT810 is ready to be used as soon as the power-up sequence has completed. However, to achieve the accuracy rating, warm up the instrument for 15 minutes.

4. Configuration



This chapter describes how to configure AT810. Include:

- Connect to Device under Test (DUT)
- Setup

4.1 Connect to Device under Test (DUT)

Figure 4-1

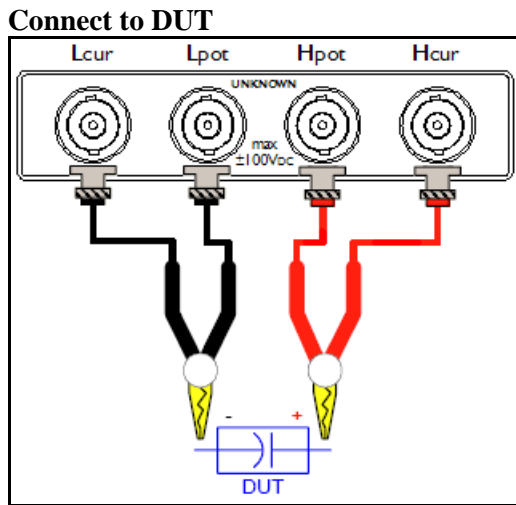

4.2 Measurement Parameter [Param Key]

The AT810 simultaneously measures three components of the complex impedance (parameters) in a measurement cycle. These include primary parameter, secondary parameter and monitor parameter.

NOTE The monitor parameters can be set by **View** key. The monitor parameters are initially set to OFF.

Types of measurement parameters

L-Q, C-D, R-Q and Z-Q

Monitor parameters

D , Q , |Z| , $\theta(\text{deg})$, $\theta(\text{rad})$, ΔABS , $\Delta\%$ and Comparator Result.

Measurement and Monitor parameter descriptions

- L: Inductance value
- C: Capacitance value
- R: Resistance value
- Z: Absolute value of impedance
- D: Dissipation factor
- Q: Quality factor(=1/D)
- $\theta(\text{rad})$: Phase radian
- $\theta(\text{deg})$: Phase angle
- ΔABS : Absolute deviation value
- $\Delta\%$: Relative deviation value

To choose measurement parameter:

- Step1: Under measurement mode, Press **[Param]** Key.
 Step2: To switch measure parameter as below:
 L-Q
 C-D
 R-Q
 Z-Q

4.3 Test Frequency [Freq Key]

Test signal frequency include: 100Hz, 120Hz, 1kHz and 10kHz.
 Test frequency accuracy: 0.02%

To choose Test frequency:

- Step1: Under measurement state, press **[Freq]** Key.
 Step2: To switch test frequency as below:
 100Hz
 120Hz
 1kHz
 10kHz

4.4 Setting the Sampling Rate [Rate Key]

The **[Rate]** operation sets the integration time of the A/D converter, the period of time the input signal is measured (also known as aperture). The integration time affects the usable digits and the amount of reading noise.

The **[Rate]** items are explained as follows, you can press **[Rate]** key to choose.

Fast: 25 readings/s. Use FAST if speed is of primary importance, at the expense of increased reading noise and fewer usable digits.

Medium: 10 readings/s. Use Medium when a compromise between noise performance and speed is acceptable.

Slow: 3 readings/s. SLOW provides better noise performance at the expense of speed

4.5 Setting the Measurement Range [Auto Key]

For any measurement range, the maximum accuracy is obtained when the measured impedance is close to the full-scale value of the measurement range being used. Conversely, if the measured impedance is much lower than the full-scale value of measurement range being used, the measurement accuracy will be reduced. This sometimes cause a discontinuity occurs in the measurement values at the measurement range boundaries. If measurement range is set to Auto range, the impedance curve will skip when impedance range change occurs. To prevent this from occurring, the impedance range should be set to the hold range mode.

Use the **[←⇒]** keys to select the desired range.
 Press the **[Auto]** key to select auto-range.

4.6 Clear Zero [Clear (Shift) Key]

The OPEN/SHORT correction for correcting the stray admittance and residual impedances can be performed.

The correction function has two kinds of correction methods. In one method the open and short correction can be performed at all of the frequency points using the interpolation method, and in the other method the open and short correction can be performed at the frequency points current used.

Before making measurements, the AT810 should be zeroed to correct for test lead

and/or fixture errors. During the zeroing process corrections are calculated and stored in instrument memory and applied to ongoing measurements.
 Open and short circuit zeroing should be done at the end of this cable.
 Generally the unit should be zeroed at least once per day and each time test leads or fixture is changed.

CLEAR:
 10KHz

1. Open or Short the test cable before clearing zero.
2. Press **Clear** key to enter clear zero page.
3. Use [**↔**] key to choose current frequency or All frequency .
4. Press **ESC** to exit this page and back to TEST state. Or press [**↔**] key to choose “OPEN” or “SHORT”.
5. Press **ENTER** to perform correction.

4.7 Comparator [Comp^(Shift) Key]

4.7.1 To setup comparator

【COMP】 Menu <Press [Knob] to select>	
NOM	Input Primary Parameter Nominal Value
D/Q	Input D or Q Limit Value
L	Low Limit
H	High Limit
BIN1	Primary Parameter Limit Bin1 (%)
L	Low Limit
H	High Limit
BIN2	Primary Parameter Limit Bin2 (%)
L	Low Limit
H	High Limit
BIN3	Primary Parameter Limit Bin3 (%)
L	Low Limit
H	High Limit

nom:
 C:
 1.0000nF

1. Press **COMP** key under TEST state.
2. Use [Knob] key to select page.
3. Use[**↔**] Key to select item.
4. Press [Number] Keys to input value.
5. Press (Shift)p,n,μ,m,k,M to enter unit.
6. Press **ENTER** or **Esc**, Value will be saved in system.

4.7.2 How the comparator work

Figure 4-2 Workflow

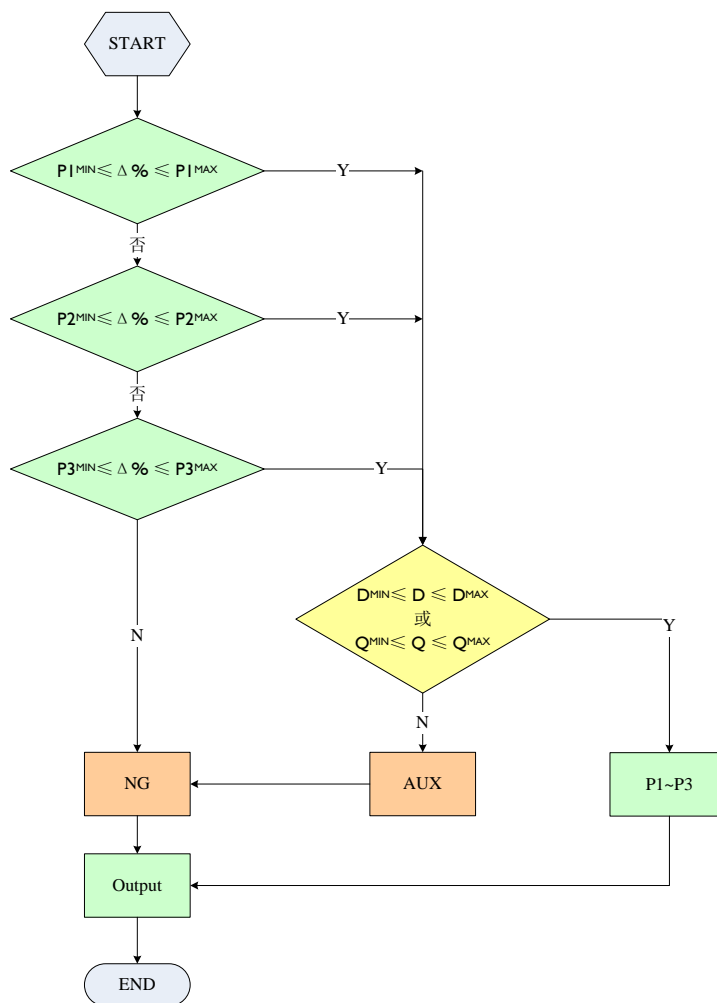

4.8 Monitor Parameter [View (Shift) Key]

Monitor parameters include:

D , Q , $|Z|$, $\theta(\text{deg})$, $\theta(\text{rad})$, ΔABS , $\Delta\%$ and Comparator Result.

The monitor parameter displays on the No.3 line.

Procedure for setting monitor parameters

Step1: Under measurement state, Press Shift+[View] Key.

Step2: To switch monitor parameter as below:

OFF, D , Q , $|Z|$, $\theta(\text{deg})$, $\theta(\text{rad})$, ΔABS , $\Delta\%$ and Comparator Result.

4.9 Menu

Under measurement state, Press Shift+[MENU] key to enter setup menu.

Press [Knob] key to select setup menu and [↔] key to select item.

【MENU】	
LEVEL	Signal Voltage Level
0.1V	0.1Vrms
0.3V	0.3Vrms
1.0V	1.0Vrms
EQU	Equivalent
SER	Serial
PAL	Parallel
sRES	Signal Source Impedance

	100Ω	100Ω
	30Ω	30Ω
BEEP		Beep Set
	OFF	
	PASS	Pass Beep on
	Fail	Fail Beep on
TRIG		Trigger Setup
	INT	Internal Trigger
	MAN	Manual Trigger
	EXT	External Trigger
COM		Remote Setup
	OFF	
	ON	The Baud rate is 9600bps

4.9.1 Signal Voltage Level (LEVEL)

The AT810’s test signal voltage level can be set as the effective value (RMS value) of a sine wave of the test frequency from the unit’s internal oscillator. The output impedance can be set to 30Ω or 100Ω.

Test signal level accuracy: 10%

After Set, the signal level indicator (0.1V,0.3V or 1V) appears lit on the VFD.

LEVEL

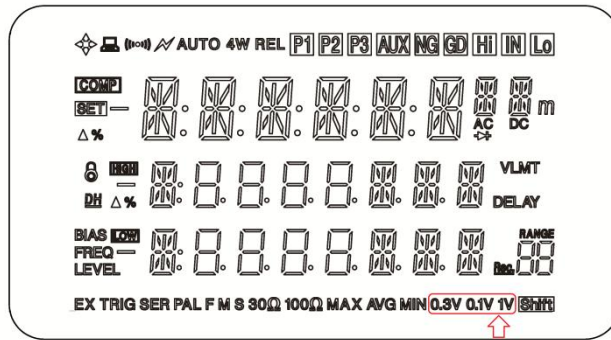

4.9.2 Equivalent Circuit (EQU)

Two equivalent circuits can be select in EQU page: Series (SER) and Parallel (PAL)

After Set, an indicator (SER or PAL) appears lit on the VFD.

eQU

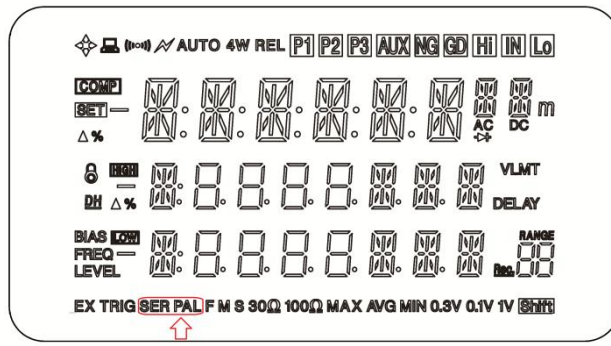

The actual C, R and L are not the ideal pure C, R and L. Normally an actual component can be regarded as the combination of an ideal resistor and an ideal reactor in series or parallel circuit mode.

AT810 can convert between the two different equivalent circuit modes using the

following equations. The measurement values of the two different circuit modes maybe different under different quality factor Q (or dissipation factor D).

Capacitance Cp: from parallel to series

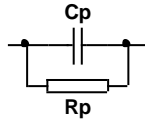

Circuit Mode :

$$\text{Dissipation : } D = \frac{1}{2\pi f C_p R_p} = \frac{1}{Q}$$

$$\text{Series : } \begin{aligned} C_s &= (1 + D^2) C_p \\ R_s &= R_p D^2 / (1 + D^2) \end{aligned}$$

Capacitance Cs : From series to parallel

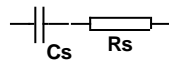

Circuit Mode :

$$\text{Dissipation: } D = 2\pi f R_s C_s = \frac{1}{Q}$$

$$\text{Parallel: } \begin{aligned} C_p &= 1/(1 + D^2) C_s \\ R_p &= R_s (1 + D^2) / D^2 \end{aligned}$$

Inductance Lp : From parallel to series

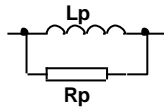

Circuit Mode :

$$\text{Dissipation: } D = \frac{2\pi f L_p}{R_p} = \frac{1}{Q}$$

$$\text{Series: } \begin{aligned} L_s &= 1/(1 + D^2) L_p \\ R_s &= R_p D^2 / (1 + D^2) \end{aligned}$$

Inductance Ls : From series to parallel

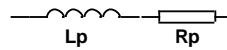

Circuit Mode :

$$\text{Dissipation : } D = \frac{R_s}{2\pi f L_s} = \frac{1}{Q}$$

$$\text{Parallel: } \begin{aligned} L_p &= (1 + D^2) L_s \\ R_p &= R_s (1 + D^2) / D^2 \end{aligned}$$

Note: Here parameter with subscript s means the series mode, parameter with subscript p means the parallel mode.

From the above equations, we can conclude that the conversion between series and parallel is determined by D^2 or Q^2 ($Q=1/D$). The value of D^2 or Q^2 directly determined the parameter values in different circuit mode.

Example:

Three capacitors have the same series capacitance: $C_s=0.1\mu\text{F}$, but their dissipations are different with each other: $D_1=0.0100$, $D_2=0.1000$, $D_3=1.0000$. According to the above equation, we can get their capacitance in parallel mode:

$$C_{p1} = 0.09999 \mu\text{F}$$

$$C_{p2} = 0.09901 \mu\text{F}$$

$$C_{p3} = 0.05000 \mu\text{F}$$

We can find that C_s is almost the same with C_p when D is very small ($D < 0.01$), but

when D is more than 0.01 , Cp and Cs are different obviously. For example: When D = 0.1 , the difference is 1% , but when D = 1 , the difference is almost 50%.

4.9.3 Source Output Impedance (SRES)

The Source output impedance can be set to 30Ω or 100Ω
 If you use AT810 to test a lower inductor, please use 30Ω.
 If you need to compare test results with Agilent 4284A, select 100Ω.

After Set,an indicator(30Ω or 100Ω) appears lit on the VFD.

SRES

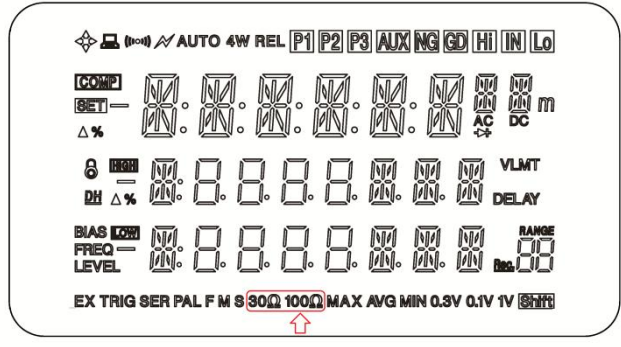

4.9.4 Beep Set(BEEP)

Three items can be select in BEEP page:
 OFF Beep off
 PASS Beep when sorting result is P1,P2 or P3
 FAIL Beep when sorting result is NG

A beep indicator appears lit on the VFD.

BEEP

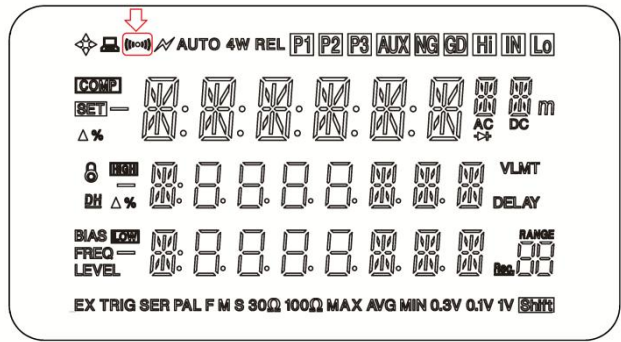

4.9.5 Trigger Set(TRIG)

AT810 supports three trigger modes: INT (internal), EXT (external), MAN (manual and BUS).

TRIG

TRIG appears lit on the VFD, which stand for manual or BUS trigger mode.
 EX TRIG appears lit on the VFD, which stand for external trigger mode.
 EX TRIG disappear which stand for internal trigger mode.

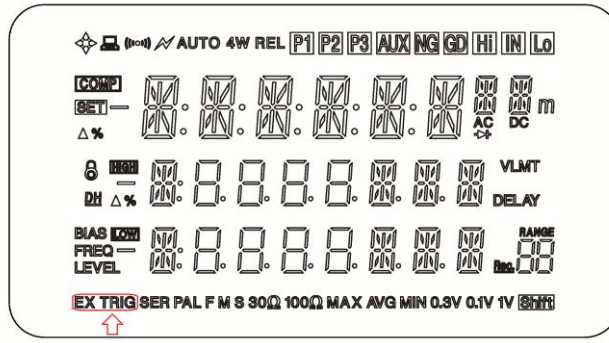

4.9.6 Remote control (COM)

About RS-232C

You can connect a controller (i.e. PC and PLC) to the RS-232 interface using Applent RS-232 DB-9 cable. The serial port uses the transmit (TXD), receive (RXD) and signal ground (GND) lines of the RS-232 standard. It does not use the hardware handshaking lines CTS and RTS.



NOTE:
 JUST ONLY Use an Applent (not null modem) DB-9 cable.
 Cable length should not exceed 2m.

Figure 4-3

The RS-232 connector in the real panel

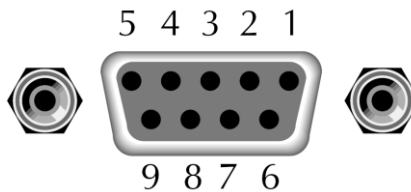

Table 4-1

RS-232 connector pinout

NAME	DB-25	DB-9	NOTE
DCD	8	1	Not Connection
RXD	3	2	Transmit data
TXD	2	3	Receive date
DTR	20	4	Not Connection
GND	7	5	Ground
DSR	6	6	Not Connection
RTS	4	7	Not Connection
CTS	5	8	Not Connection

Make sure the controller you connect to AT810 also uses these settings.

The RS-232 interface transfers data using:

8 data bits, 1 stop bit and no parity.

An indicator appears lit on the VFD.

COM

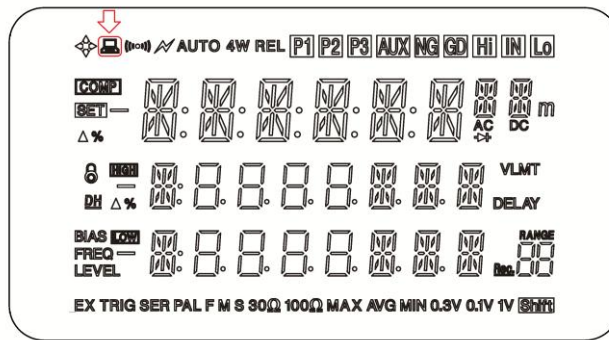

5. Handler Interface



This chapter describes how to use the handler interface.

- Pin Assignment
- Circuit Diagram
- Timing Chart

By using the handler interface, you can output the measurement completion signal (EOC), the screening result of the comparator function (GD/NG/HI/IN/LO), and so on to external devices from the AT810. You can also input the external trigger signal and the comparator select signal to the AT810. With this interface and the comparator function, you can build an automatic screening system composed of the AT810 and the handler.

5.1 Pin Assignment

Table 5-1 Pin assignment

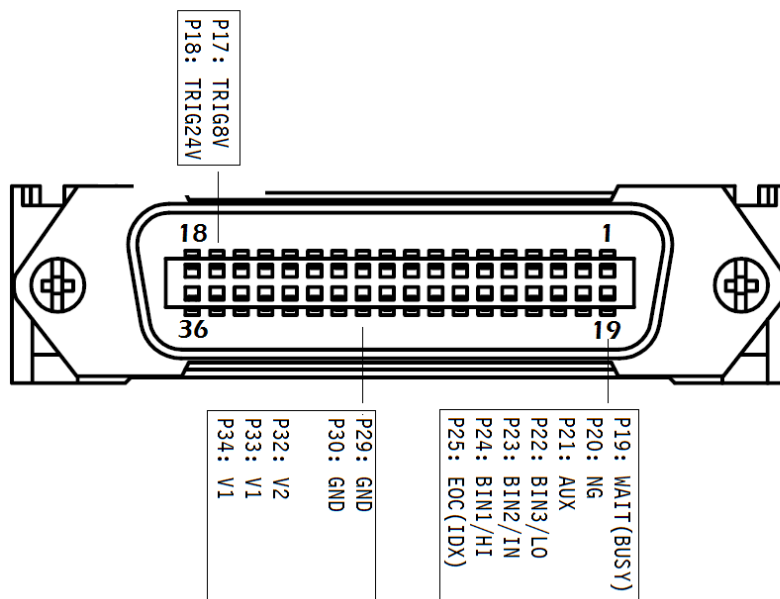

Table 5-2 Output Signals

19	WAIT(EOM)	“End of measurement cycle” signal. When this signal is output, the measurement data and sorting results are available. (Low)
20	NG	The result of sorting. Open-collector based. (LOW)
21	AUX	
22	BIN3	
23	BIN2	
24	BIN1	“End of analog measurement” signal. This signal is output when analog measurement is complete. This means that once the handler has received this signal, the next DUT can be connected to the UNKNOWN terminal. However, measurement data are not
25	EOC(IDX)	

		available until the EOM signal is output.
--	--	---

Table 5-3

Input Signals

17	TRIG-8V	An external trigger signal for 8V. Connect to this pin when V1 = 5~8V.
18	TRIG-24	An external trigger signal for 24V. Connect to this pin when V1=8~24V

Table 5-4

Power Signal

32	V2	The power of built-in 5kΩ pull-up resistance of the output signals.
33-34	V1	External DC Voltage. Supplies voltage for IDX and EOM signal pull-up resistance.
29-30	GND	Common signal for external DC current V1,V2

5.2 Power Rating

	Input/Output device	Logic	Electrical requirements
OUTPUT	Corrector out with pull-up resistance	Negative logic	35VDC 50mADC max
INPUT		Negative logic	50mADC max
EXT.DCV	DC voltage input		35VDC max

5.3 Electrical Characteristics

5.3.1 Input Signal:

Each input signal is connected to the LED (cathode side) of the photo-coupler. The LED (anode side) is connected to the pull-up power supply voltage.

5.3.2 Output Signal:

Each output signal is outputted via a open collector by using a photo-coupler. The voltage of each output is obtained by connecting pull-up resistors, inside or outside of the AT810.

5.3.3 Power supply

The power supply for the judgment output signal pull-up and that for the operation output signal pull-up and input signal drive can be set separately. You can select from +3.3V to +35V external power supply.

Figure 5-1

Typical Circuit Diagram of Handler Interface Input signals.

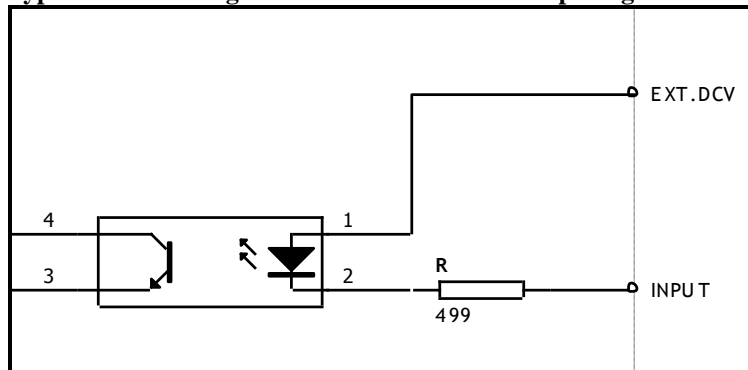
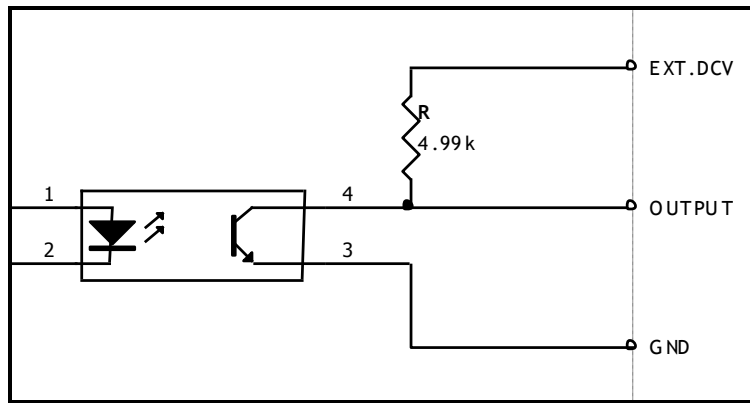

Figure 5-2

Typical Circuit Diagram of Handler Interface Output signals.



5.4 Timing Chart

Figure 5-3

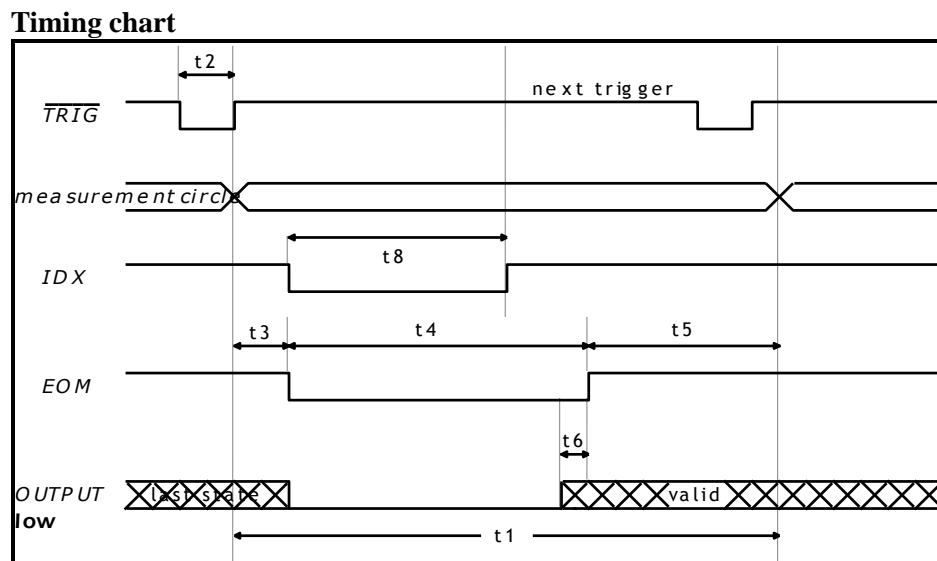

Table 5-5 Timing

	Description			Time		
				MIN	TYP	MAX
t1	One Measurement Circle	FAST	100Hz	-	180ms	-
			120Hz	-	160ms	-
			1kHz	-	67ms	-
			10kHz	-	67ms	-
		MED	100Hz	-	260ms	-
			120Hz	-	225ms	-
			1kHz	-	235ms	-
			10kHz	-	235ms	-
		SLOW	100Hz	-	500ms	-
			120Hz	-	425ms	-
			1kHz	-	580ms	-
			10kHz	-	580ms	-
t2	Trigger pulse width			1ms	-	-
t3	Trigger delay time			-	25 μ s	-
t4	AD Time (EOM)	FAST	100Hz	-	164ms	-
			120Hz	-	136ms	-
			1kHz	-	48ms	-
			10kHz	-	48ms	-
		MED	100Hz	240ms	250ms	260ms
			120Hz	-	216ms	-
			1kHz	-	232ms	-
			10kHz	216ms	224ms	-
		SLOW	100Hz	460ms	480ms	-
			120Hz	400ms	420ms	-
			1kHz	-	560ms	-
			10kHz	540ms	560ms	-
t5	Print Result Time			8ms	-	8.8ms
t6	Handler out to EOM time			-	10 μ s	-

6. Specification



This chapter describes the specifications and supplemental performance characteristics of the AT810 :

- Specifications
- Dimension

Accuracy is defined as meeting all of the following conditions.

Temperature: $23^{\circ}\text{C} \pm 5^{\circ}\text{C}$

Humidity: $\leq 65\%$ R.H.

Zeroing: Open and Short Correction

Warm up time is 30 min or more.

Rate: Slow

A 1-year calibration cycle

Test frequency accuracy: 0.02%

Test signal level: 10%

Basic Accuracy: 0.1%

6.1 General Specification

Display: Vacuum-Fluorescent-Display (4-Colors VFD) Size: 98x55mm

Test Function: L-Q, C-D, R-Q and Z-Q

Test Frequency: 100Hz, 120Hz, 1kHz and 10kHz

Measurement Range

Parameter	Measurement Range
L	0.01 μH ~ 9999H
C	0.01pF ~ 9999mF
R、 Z	0.0001 Ω ~ 99.99M Ω
D	0.0001 ~ 9.999
Q	0.0001 ~ 999.9
θ_d	-179.99 $^{\circ}$ ~ 179.99 $^{\circ}$
θ_r	-3.1416 ~ 3.1416

Measurement Speed: 25 times/s, 10 times/s, 3times/s

Output impedance: 30 Ω , 50 Ω and 100 Ω ,

Ranging: Auto, Hold range. Total 6 Ranges.

Equivalent Circuit: Serial and Parallel

Correction Function: OPEN/SHORT

Beep Feature: OFF/PASS/FAIL

Trigger Mode: Internal, Manual, External and Bus Trigger.

Built-in Interface: Handler interface and RS232 interface.

Programming language: SCPI

Environment :

Temperature and humidity range : 15°C - 35°C ,80% RH or less

Operating temperature and humidity range : 10°C~40°C,10~90% RH

Storage temperature and humidity range: 0°C~50°C,10~90% RH

Power Supply : AC 198 ~ 252V, 48.5Hz ~ 62.5Hz

Fuse: 1A Slow-Blow

Maximum rated power : 30VA

Weight : 3.5kg, net

6.2 Dimensions

