

# User's Guide

Rev.B0

# AT526/AT526B

## Battery Internal Resistance Meter



### Applent Instruments Inc.

Address: 3 Floor, No. 61, Baolong International, Changzhou, Jiangsu, China (PRC)

Post Code: 213014

Tel: 0086-0519-88805550

Fax: 0086-0519-86922220

Sales Email: [sales@applent.com](mailto:sales@applent.com)

Tech Email: [tech@applent.com](mailto:tech@applent.com)

<http://www.applent.com>

## CERTIFICATION, LIMITED WARRANTY, & LIMITATION OF LIABILITY

**Applent Instruments, Ltd.** (shortened form **Applent**) certifies that this product met its published specifications at the time of shipment from the factory. Applent further certifies that its calibration measurements are traceable to the People's Republic of China National Institute of Standards and Technology, to the extent allowed by the Institution's calibration facility or by the calibration facilities of other International Standards Organization members.

This Applent instrument product is warranted against defects in material and workmanship for a period corresponding to the individual warranty periods of its component products. **The warranty period is 1 year and begins on the date of shipment.** During the warranty period, Applent will, at its option, either repair or replace products that prove to be defective. This warranty extends only to the original buyer or end-user customer of a Applent authorized reseller, and does not apply to fuses, disposable batteries or to any product which, in Applent's opinion, has been misused, altered, neglected or damaged by accident or abnormal conditions of operation or handling.

For warranty service or repair, this product must be returned to a service facility designated by Applent. The buyer shall prepay shipping charges to Applent and Applent shall pay shipping charges to return the product to the Buyer. However, the Buyer shall pay all shipping charges, duties, and taxes for products returned to Applent from another country.

Applent warrants that its software and firmware designated by Applent for use with an instrument will execute its programming instruction when properly installed on that instrument. Applent does not warrant that the operation of the instrument, or software, or firmware, will be uninterrupted or error free.

The foregoing warranty shall not apply to defects resulting from improper or inadequate maintenance by the Buyer, Buyer-supplied software or interfacing, unauthorized modification or misuse, operation outside the environmental specifications for the product, or improper site preparation or maintenance.

THIS WARRANTY IS BUYER'S SOLE AND EXCLUSIVE REMEDY AND IS IN LIEU OF ALL OTHER WARRANTIES, EXPRESS OR IMPLIED, INCLUDING BUT NOT LIMITED TO ANY IMPLIED WARRANTY OF MERCHANTABILITY OR FITNESS FOR A PARTICULAR PURPOSE. APPLMENT SHALL NOT BE LIABLE FOR ANY SPECIAL, INDIRECT, INCIDENTAL OR CONSEQUENTIAL DAMAGES OR LOSSES, INCLUDING LOSS OF DATA, WHETHER ARISING FROM BREACH OF WARRANTY OR BASED ON CONTRACT, TORT, RELIANCE OR ANY OTHER THEORY.

Applent Instruments, Ltd.  
Changzhou,  
Jiangsu,  
China,  
Rev.A2 January, 2005  
Rev.B0 January, 2008

# Contents

CERTIFICATION, LIMITED WARRANTY, & LIMITATION OF LIABILITY .....	2
Contents .....	3
Figure Contents.....	5
Table Contents .....	5
1. Unpacking and Preparation.....	6
1.1 Incoming Inspection .....	6
1.2 Power requirements and setting up Fuse .....	6
1.3 Environmental Requirements .....	6
1.4 Cleaning.....	7
1.5 How to Remove the Handle.....	7
2. Overview .....	9
2.1 Introduction.....	9
2.2 Main Specifications and Features .....	9
2.3 Main Functions .....	10
2.3.1 Correction .....	10
2.3.2 Comparator (Sorting Function).....	10
2.3.3 System Setup .....	10
2.3.4 Remote Control.....	10
3. Startup.....	11
3.1 Front panel.....	11
3.2 Rear Panel.....	11
3.3 Power On/Off.....	12
3.3.1 Line Power Connection .....	12
3.4 Warm-up Time .....	12
3.5 Connect to Device under Test (DUT) .....	12
4. <Meas> Key .....	13
4.1 <MEAS DISPLAY> Page.....	13
4.1.1 [TRIGGER] .....	13
4.1.2 [RANGE].....	14
4.1.3 Measurement Speed [SPEED] .....	15
4.1.4 [BEEP] Feature .....	16
4.2 Status Bar on <MEAS DISPLAY>.....	16
4.2.1 Icons on <MEAS DISPLAY>.....	16
4.2.2 [VIEW DATA] Soft-key .....	16
4.2.3 [SAVE DATA] Soft-key.....	16
4.3 <VIEW DATA> page.....	16
5. [SETUP] Key.....	18
5.1 < SETUP> page .....	18
5.2 Short-circuit Clear Zero [CLEAR ZERO].....	18
5.3 Comparator Mode [R-COMP],[V-COMP] .....	19
5.3.1 Comparator Nominal [R-NOMINAL],[V-NOMINAL].....	19
5.3.2 Limit [R-LOWER] [R-UPPER] [V-LOWER], [V-UPPER] .....	19
6. <SYSTEM CONFIG> page.....	21
6.1 <SYSTEM CONFIG> page.....	21
6.1.1 [LANGUAGE].....	21
6.1.2 [ACCOUNT], [PASSWORD] .....	22
6.1.3 [DATE], [TIME] .....	22
6.1.4 RS232 [BAUD] rate.....	23
6.1.5 RS-232 Shake Hand [SHAKE HAND] .....	23
6.1.6 RS-232 Result Send Mode [RESULT SEND] .....	23
6.2 <SYSTEM INFORMATION>.....	24
6.3 <SYSTEM SERVICE> page .....	25
7. Handler Interface (Optional for AT526B).....	25
7.1 Pin Assignment .....	25

7.2	Power Rating .....	26
7.3	Electrical Characteristics .....	26
7.3.1	Input Signal:.....	26
7.3.2	Output Signal:.....	26
7.3.3	Power supply .....	26
7.3.4	Schematic.....	26
8.	Remote Control.....	28
8.1	About RS-232C .....	28
8.2	About USB-Serial Interface (Option) .....	29
8.3	To Select Baud Rate.....	29
8.4	SCPI Language .....	30
9.	Command Reference .....	31
9.1	Terminator.....	31
9.2	Notation Conventions and Definitions.....	31
9.3	Command Structure .....	31
9.4	Header and Parameters .....	32
9.5	Command Reference.....	33
9.6	DISPlay Subsystem .....	33
9.6.1	DISP:PAGE.....	33
9.6.2	DISP:LINE .....	34
9.7	FUNcTION Subsystem .....	34
9.7.1	FUNcTION:RANGe .....	34
9.7.2	FUNcTION:RANGe:MODE .....	34
9.7.3	FUNcTION:RATE .....	34
9.8	COMParator Subsystem .....	35
9.8.1	COMParator:RMODE.....	35
9.8.2	COMParator:VMODE.....	35
9.8.3	COMParator:BEEP.....	35
9.8.4	COMParator:TOLerence:RNOMinal.....	35
9.8.5	COMParator:TOLerence:RLiMiT .....	36
9.8.6	COMParator:TOLerence:VNOMinal .....	36
9.8.7	COMParator:TOLerence:VLiMiT .....	36
9.9	TRIGger Subsystem.....	36
9.9.1	TRIGger[:IMMediate] .....	36
9.9.2	TRIGger:SOURce.....	37
9.9.3	TRG .....	37
9.10	FETCh Subsystem .....	37
9.10.1	FETCh?.....	37
9.11	CORRection Subsystem .....	37
9.11.1	CORRection:SHORT.....	37
9.12	SYSTem subsystem .....	38
9.12.1	SYSTem:SENDmode.....	38
9.13	ERRor Subsystem.....	38
9.14	IDN? .....	38
9.15	SAV .....	38
10.	Specification .....	39
10.1	General Specifications .....	39
10.2	About Accuracy .....	39
10.3	AC Resistance Range for AT526 .....	40
10.4	AC Resistance Range for AT526B.....	40
10.5	DC Voltage Range for AT526 .....	40
10.6	DC Voltage Range for AT526B.....	40
10.7	Features.....	40
10.8	Environment .....	41
10.9	Dimensions .....	41

# Figure Contents

Figure 1-1	How to remove the handle .....	8
Figure 3-1	Front panel .....	11
Figure 3-2	Rear Panel .....	11
Figure 3-3	Connect to DUT .....	12
Figure 7-1	Pin Assignment .....	25
Figure 7-2	Typical Circuit Diagram of Handler Interface Input signals .....	26
Figure 7-3	Typical Circuit Diagram of Handler Interface Output signals .....	27
Figure 8-1	The RS-232 connector in the rear panel .....	28
Figure 8-2	USB-Serial Interface ATN2 .....	29
Figure 9-1	Command Tree Example .....	31
Figure 9-2	DISP Command Tree .....	33
Figure 9-3	FUNCTion Subsystem Tree .....	34
Figure 9-4	COMParator Subsystem Command Tree .....	35
Figure 9-5	TRIGger Subsystem Command Tree .....	36
Figure 9-6	FETCh Subsystem Command Tree .....	37
Figure 9-7	CORRection Subsystem Command Tree .....	37
Figure 9-8	SYSTem commad tree .....	38
Figure 10-1	Dimensions .....	41

# Table Contents

Table 3-1	Front panel description .....	11
Table 3-2	Rear panel description .....	12
Table 7-1	Description of Handler Interface Signals .....	25
Table 8-1	RS-232 connector pinout .....	28
Table 9-1	Multiplier Mnemonics .....	33

# 1. Unpacking and Preparation



This chapter describes how to set up and start the AT526/AT526B.

- Incoming Inspection
- Power Requirements
- Setting up the Fuse
- How to Remove the Handle
- Environmental Requirements
- Cleaning

## 1.1 Incoming Inspection

After you receive the instrument, carry it out and check during unpacking according to the following procedures.



If the external face of the instrument (such as the cover, front/rear panel, LCD screen, power switch, and port connectors) appears to have been damaged during transport, do not turn on the power switch. Otherwise, you may get an electrical shock.

Make sure that the packing box or shock-absorbing material used to package the instrument has not been damaged.

Referring to <Packing List> in the packing box, check that all packaged items supplied with the meter have been provided as per the specified optioned.

### NOTE

If an abnormality is detected, contact the company and transport the meter to your nearest Applent Instruments sales or service office. For inspection by the transport company, save the packing box, shock-absorbing material, and packaged items as you received them.

## 1.2 Power requirements and setting up Fuse

~Line: 220VAC, 50Hz/60Hz

Fuse: 250V 1A Slow Blow

Please use the following fuse type.

UL/CSA type, Slow-Blow, 5×20-mm miniature fuse, 1A, 250 V



When you need a fuse, contact your nearest Applent Instruments sales or service office. To verify and replace the fuse, remove the power cable and pull out the fuse holder.

## 1.3 Environmental Requirements

Set up the AT526/AT526B where the following environmental requirements are satisfied.

Operating Environments

Ensure that the operating environment meets the following requirements.

Temperature: 0°C to 55°C

Temperature range at calibration:  $23^{\circ}\text{C} \pm 5^{\circ}\text{C}$  ( $< 1^{\circ}\text{C}$  deviation from the temperature when performing calibration)

Humidity: 15% to 85% at wet bulb temperature  $\leq 40^{\circ}\text{C}$  (non-condensation)

Altitude: 0 to 2,000m

Vibration: Max. 0.5 G, 5 Hz to 500 Hz

## 1.4 Cleaning

To prevent electrical shock, disconnect the AT526/AT526B power cable from the receptacle before cleaning.

Use a dry cloth or a cloth slightly dipped in water to clean the casing.

Do not attempt to clean the AT526/AT526B internally.



**WARNING:** Don't Use Organic Solvents (such as alcohol or gasoline) to clean the Instrument.

## 1.5 How to Remove the Handle

A handle kit is attached to the AT526/AT526B:

Figure 1-1 How to remove the handle

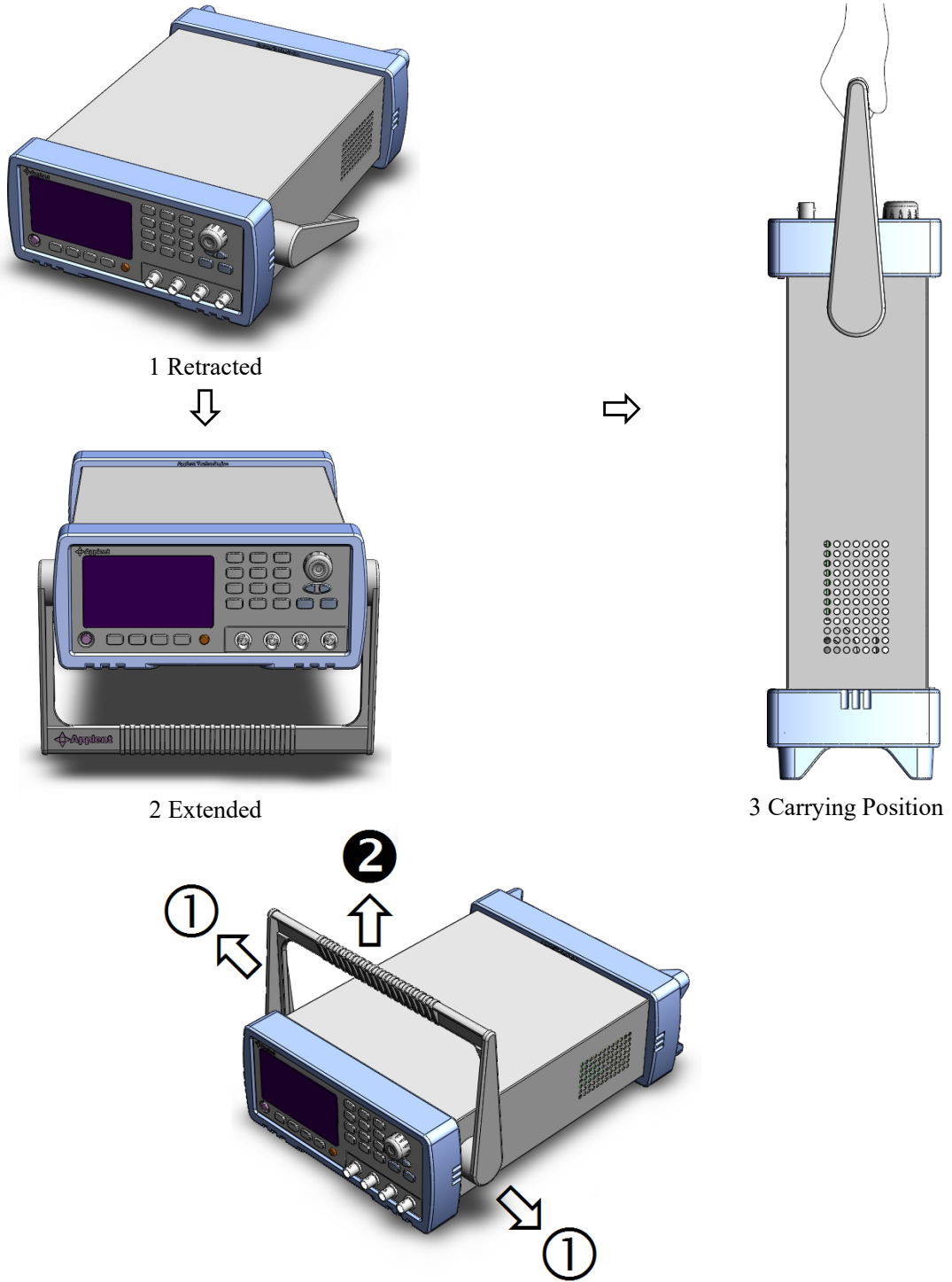

Remove Handle ( Lift the handle perpendicular to the unit while pulling it in the direction of 1.)



## 2. Overview

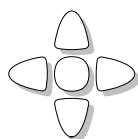

This chapter contains general information about AT526/AT526B. The information is organized as follows

- Introduction
- Main Specifications
- Feature overview

### 2.1 Introduction

Thank you for choosing AT526/AT526B Battery Internal Resistance Meter.

AT526/AT526B adopts high-performance 32-bit ARM processor. It is a meter with wide resistance measurement range from 0.001mΩ to 33kΩ (AT526B: 0.001mΩ- 33.00Ω) and DC voltage range from 0.00000V to 120.0000V (AT526B: 0.0001V-60.000VDC).

The instrument features an m-Ohm and V mode that allows simultaneous measurement and comparison of battery internal resistance and open-circuit voltage. This meter is highly suitable for battery inspection lines as one unit can act as both a low-resistance meter and a voltmeter.

The AT526/AT526B completes with comparator function and external interface (handler, AT526B: handler interface is optional) utilizing the principles of the AC 4-terminal method that gives priority to line use and offers high speed, high accuracy and high resolution.

With its built-in comparator, the AT526/AT526B can output comparison/decision results for sorting components into resistance HIGH-IN-LOW bins and voltage HIGH-IN-LOW bins.

AT526/AT526B measures all kinds of battery's resistance and DC voltage, such as lithium batteries, lead-acid batteries, Button Cell Batteries and etc. Especially, AT526/AT526B can measure UPS battery while UPS working online.

AT526/AT526B is equipped with RS232 interface to apply to remote control, data acquisition and analysis.

AT526/AT526B is also equipped with USB-Disk interface, and you can store the test values into your USB Disk over 500 sets.

### 2.2 Main Specifications and Features

- Basic Accuracy: Resistance: 0.2% Voltage: 0.05% (AT526);
- Resistance: 0.5% Voltage: 0.05% (AT526B)
- Test Frequency: 1kHz±2Hz
- Max Display: Resistance: 33,000 digit, DC Voltage: 1,200,000 digit (AT526); Resistance: 33,000, Voltage: 60,000 (AT526B)
- 7 ranges with Auto and Manual Modes (AT526); 4 ranges with Automatic and Manual (AT526B)
- Four-terminal test method
- Test Speed: 145 times/s (Ultra Speed Mode) for AT526; 30 t/s, 10 t/s, 1 t/s for

AT526B

- Trigger Mode: Internal, Manual, External and Remote trigger

## 2.3 Main Functions

### 2.3.1 Correction

Short-circuit Clear Zero correction for all ranges.

### 2.3.2 Comparator (Sorting Function)

Set up sorting function to do OK/NG sorting.

**Comparator Methods:**

Absolute value of tolerance  $\pm$ TOL sorting

Percentage tolerance  $\pm$ TOL sorting

Sequence comparison sorting

**Beep Feature:**

Beep: OFF/GD/NG

### 2.3.3 System Setup

- Keypad Lock Function
- Switch Both in Chinese and English
- Time and Date Settings
- Administrator Accountant Settings

### 2.3.4 Remote Control

Max baud rate: 115200bps, SCPI available, ASCII transmit.

# 3. Startup

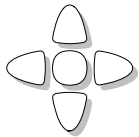

This chapter describes names and functions of the front panel, rear panel, and screen display and provides the basic procedures for operating AT526/AT526B.

- Front panel summary
- Rear panel summary
- Power On/Off
- Connect to Device under Test

## 3.1 Front panel

Figure 3-1

Front panel

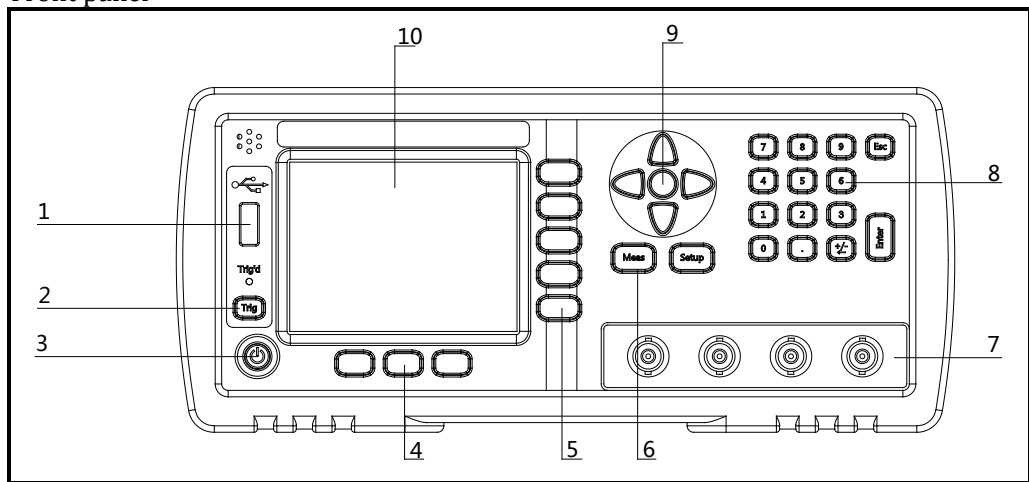

Table 3-1

Front panel description

No.	Description
1	USB Disk Port (USB-Host)
2	Trigger Key
3	Power Switch
4	System Key (Include File, System and Key Lock)
5	Soft Key
6	Menu key
7	UNKNOWN Terminal
8	Entry Key
9	Cursor Key
10	LCD Display

## 3.2 Rear Panel

Figure 3-2

Rear Panel

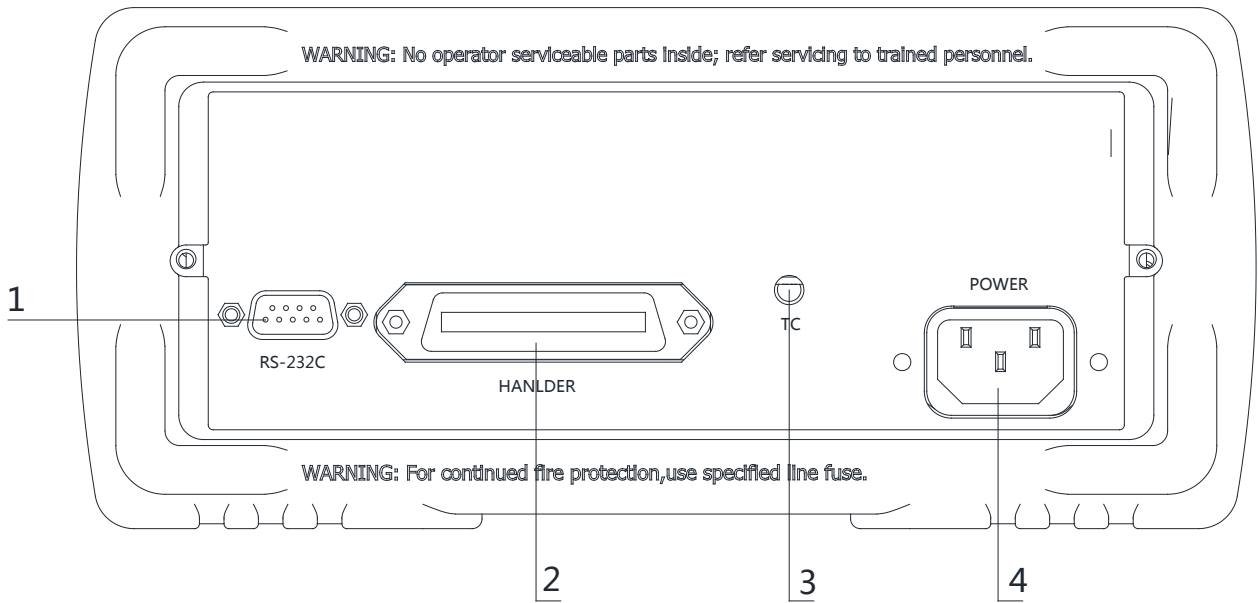

Table 3-2

Rear panel description

No.	Description
1	RS-232C Interface
2	Handler Interface (Optional for AT526B)
3	Temperature Compensation Interface
4	AC Power Cord Receptacle

### 3.3 Power On/Off

#### 3.3.1 Line Power Connection



### 3.4 Warm-up Time

AT526/AT526B is ready to be used as soon as the power-up sequence has completed. However, to achieve the accuracy rating, warm up the instrument for 30 minutes.

### 3.5 Connect to Device under Test (DUT)

Figure 3-3

Connect to DUT

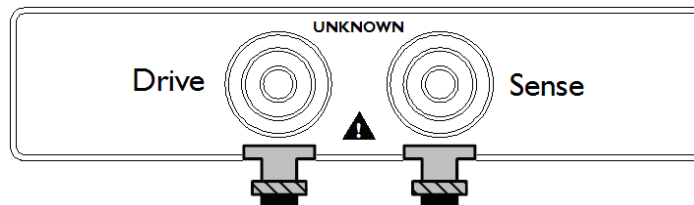

Warning:

No putting current source, voltage source directly access to test side. Energy storage device access to testing after discharging.

Be sure to ensure the floating state for a battery circuit with voltage exceeds 130VDC

## 4. <Meas> Key

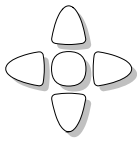

This section includes the following information:  
 MEAS DISPLAY page  
 VIEW DATA page

### 4.1 <MEAS DISPLAY> Page

Press [Meas] key to enter <MEAS DISPLAY>Page.

The <MEAS DISPLAY> page includes following setup :

- Trigger Mode [TRIGGER]
- Measurement Range [RANGE]
- Test Speed [SPEED]
- Comparator [COMP] ON/OFF
- [BEEP] Feature
- Soft-key VIEW DATA – To Enter [VIEWDATA] page
- Soft-key SAVE DATA – To Store measurement result into internal flash disk.

Figure 4-1 <MEAS DISPLAY>Page



(Ultra-Fast Speed Mode)

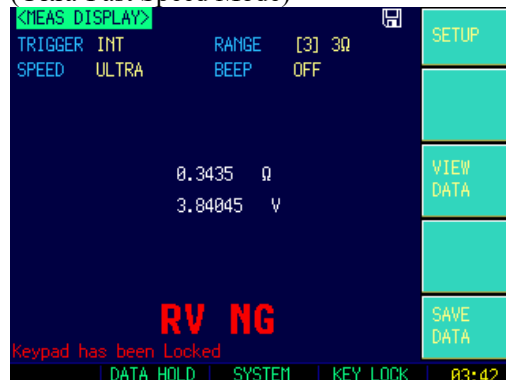

#### 4.1.1 [TRIGGER]

SCPI Command: `TRIGger: SOURce {INT, MAN, EXT, BUS}`

SCPI Query Command: `TRIGger: SOURce?`

AT526/AT526B supports four trigger modes: INT (internal), EXT (external), MAN

(manual) and BUS (RS-232)

Table 4-1 Trigger Setting

Trigger Mode	Description
INT	Continuously repeats the measurement cycle.
MAN	Performs one cycle of measurement each time you press the [Trig] key.
EXT	Performs one cycle of measurement each time a rising pulse is input to the handler external trigger input pin on the rear panel.
BUS	Performs one cycle of measurement each time it receives a trigger command sent via RS-232.

■ Procedure to setting the trigger:

Step 1	Press [Meas] key to enter <MEAS DISPLAY>Page	
Step 2	Use cursor keys to select [TRIGGER] field	
Step 3	INT	Automatic Internal trigger
	MAN	Manual Trigger by pressing [Trig] key
	EXT	External Trigger Mode
	BUS	BUS Trigger by RS232 SCPI command

4.1.2 [RANGE]

SCPI Command: **FUNCTION:RANGE {<range number>,min,max}**

SCPI Command: **FUNCTION:RANGE:MODE {AUTO,HOLD,NOMINAL}**

SCPI Query Command: **FUNCTION:RANGE?**

SCPI Query Command: **FUNCTION:RANGE:MODE?**

AT526/AT526B has three resistance range modes and two voltage range.

**Resistance Ranges:**

Auto range, Manual range and Nominal range

Table 4-2 Resistance Range Mode

Range	Description	Pros	Cons
AUTO	Automatically select the best range according to impedance Range is automatically set.	Very convenient	Test speed is slower than manual ranging,
HOLD	The instrument will always uses the user-specified range	Highest speed	Set the range previously
NOMINAL	Automatically select the best range according to nominal value.	Best mode for sorting.	Only available in sorting mode

Table 4-3 Resistance Measurement Ranges of AT526

Range	Range Name	Measurement Range
7	30kΩ	3.2kΩ ~ 33kΩ
6	3kΩ	320Ω ~ 3.3kΩ
5	300Ω	32Ω ~ 330Ω
4	30Ω	3.2Ω ~ 33Ω
3	3Ω	320mΩ ~ 3.3Ω
2	300mΩ	32mΩ~ 330mΩ
1	30mΩ	0 ~ 33mΩ

Table 4-4 Resistance Measurement Ranges of AT526B

Range	Range Name	Measurement Range
4	30Ω	3.2Ω ~ 33Ω
3	3Ω	320mΩ ~ 3.3Ω
2	300Ω	32mΩ ~ 330mΩ
1	30mΩ	0 ~ 33mΩ

■ Procedure of setting the range:

Step 1	Press [Meas] key to enter measurement page	
Step 2	Use the cursor key to select [RANGE]	
Step 3	AUTO	Auto range
	HOLD	Current range is hold
	NOMINAL	Select the range according to resistance nominal value [RNom].
	INCR+	Increase range
	DECL-	Decline range

**Voltage Ranges:**

Table 4-5 Voltage Measurement Ranges of AT526

Range	Range Name	Measurement Range
1	120V	12.0V~120V
0	12V	0V~12.2V

Table 4-6 Voltage Measurement Ranges of AT526B

Range	Range Name	Measurement Range
1	60V	12.0V~60V
0	12V	0V~12.2V

The DC voltage measurement range cannot be selected. AT526/AT526B always uses automatic range mode under SLOW, MED and FAST speed mode and use the maximum range under ULTRA speed mode (ULTRA speed only for AT526).

**4.1.3 Measurement Speed [SPEED]**

SCPI Command: `FUNCTION:RATE {SLOW,MED,FAST,ULTRA}`

SCPI Query Command: `FUNCTION:RATE?`

SLOW, MED, FAST and ULTRA speed mode can be selected for AT526.

SLOW mode will result in more stable and accurate measurement result.

The following speed is measured in range-hold mode and comparator is ON:

AT526:

- SLOW: 1 times/sec (1s)
- MED: 10 times/sec (100ms)
- FAST: 30 times/sec (33ms)
- ULTRA: 145 times/sec (6.8ms)

AT526B:

- SLOW: 1 times/sec (1s)
- MED: 10 times/sec (100ms)
- FAST: 30 times/sec (33ms)

□ Procedure to setting test speed:

Step 1	Press [Meas] key to enter measurement page;	
Step 2	Use the cursor key to select [SPEED] field	
Step 3	SLOW	

	MED	
	FAST	
	ULTRA	Small font

**4.1.4 [BEEP] Feature**

SCPI Command: `COMParator:BEEP {OFF, GD, NG}`

SCPI Query Command: `COMParator:BEEP`

- Procedure to setting the beep:

Step 1	Press [Meas] key to enter measurement page;	
Step 2	Use the cursor key to select [BEEP]	
Step 3	OFF	Turn Beep Off
	GD	Beep while Pass
	NG	Beep while Fail

**4.2 Status Bar on <MEAS DISPLAY>**

- HOLD – Hold the data under internal trigger mode, test stops.
- SYSTEM– Go to <SYSTEM CONFIG>Page
- KEY LOCK – Lock the keypad.
- Time

**4.2.1 Icons on <MEAS DISPLAY>**

Table 4-5 Icons

Icon	Description
	USB-Disk is available.
H	Hold current data.

**4.2.2 [VIEW DATA] Soft-key**

To enter the <VIEW DATA> page by pressing [VIEW DATA] soft-key.

**4.2.3 [SAVE DATA] Soft-key**

Every time press this key, a line of measurement result will be stored into internal flash disk.

The saved data can be reviewed on <VIEW DATA> page by pressing [VIEW DATA] soft-key.

**4.3 <VIEW DATA> page**

The measurement result can be stored in AT526's/AT526B's internal nonvolatile memory by press the [SAVE DATA] soft-key in <MEAS DISPLAY> page. Over 500 sets data can be saved.

The format of measurement result is:  
 [Resistance][Voltage][Date][Time]

You can review the saved data on the <VIEW DATA> page by pressing the [VIEW DATA] soft-key in <MEAS DISPLAY> page.

Figure 4-2 <VIEWDATA> page



The screenshot shows a device's data view menu. At the top, there is a title bar with '<VIEW DATA>' and a USB icon. Below this is a table with 10 rows of data. To the right of the table is a vertical menu with options: 'SAVE TO USB DISK', 'RESET', 'FORMAT', 'PAGE UP', and 'PAGE DOWN'. Below the table, the text 'Page 1' is displayed. At the bottom of the screen, a status bar shows 'Keypad has been Locked', 'PAGE', 'SYSTEM', 'KEY LOCK', and '13:29'.

Line	Value 1	Unit 1	Value 2	Unit 2	Time
1	0.233	Ω	3.791	V	2012-08-20, 13:20:57
2	0.233	Ω	3.791	V	2012-08-20, 13:20:59
3	0.233	Ω	3.791	V	2012-08-20, 13:21:01
4	0.233	Ω	3.791	V	2012-08-20, 13:21:10
5	0.236	Ω	3.791	V	2012-08-20, 13:27:00
6	0.236	Ω	3.791	V	2012-08-20, 13:27:06
7	OL	kΩ	0.000	V	2012-08-20, 13:27:14
8	0.00	mΩ	0.000	V	
9	0.00	mΩ	0.000	V	
10	0.00	mΩ	0.000	V	

- SAVE TO DISK – Store all data into USB Disk
- RESET – The data will be stored from the start of the table.
- FORMAT – To format the internal nonvolatile memory disk, all data will be lost.
- PAGE – Jump to the provided page

## 5. [SETUP] Key



This chapter describes:

- <SETUP> page
- Short-circuit Clear Zero

### 5.1 < SETUP > page

Press [Setup] key to enter <SETUP>page.

In <SETUP> page, the Instrument does not display measurement result and comparator result, testing is not in progress.

The <SETUP> page includes following setup :

- Trigger Mode [TRIGGER]
- Measurement Range [RANGE]
- Measurement Speed [SPEED]
- BEEP Feature
- Soft-key CLEAR ZERO – Clear Zero Correction
- R-COMP – AC Resistance Sorting Methods
- V-COMP – DC Voltage Sorting Methods
- R-NOMINAL – Input Resistance Nominal Value
- R-LOWER – Input Resistance Lower Limit
- R-UPPER – Input Resistance Upper Limit
- V-NOMINAL – Input Voltage Nominal Value
- V-LOWER – Input Voltage Lower Limit
- V-UPPER – Input Voltage Upper Limit

Some settings can be also set up in <MEAS DISPLAY> page. Please refer to the chapter: <Meas> Key

Figure 5-1 <SETUP>page

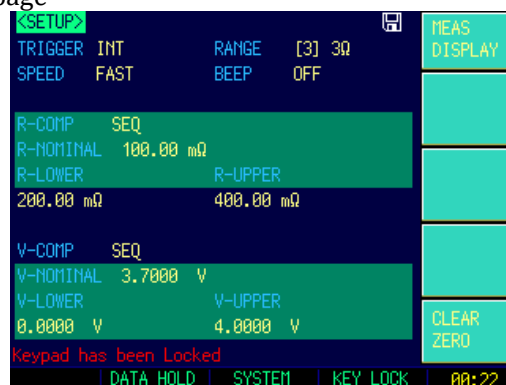

### 5.2 Short-circuit Clear Zero [CLEAR ZERO]

SCPI Command: `CORR: SHOR`

Press [Setup] key to enter < SETUP > page, and then press [CLEAR ZERO] soft-key to perform short-circuit clear zero.

After correction, the value will be saved into internal flash disk.



It is necessary to do short-circuit clear zero correction.  
When replace the test fixture or test cables, please do short –circle clear zero.

How to connect the test clips before executing short-circuit clear.

Figure 5-2 Connect the test clip

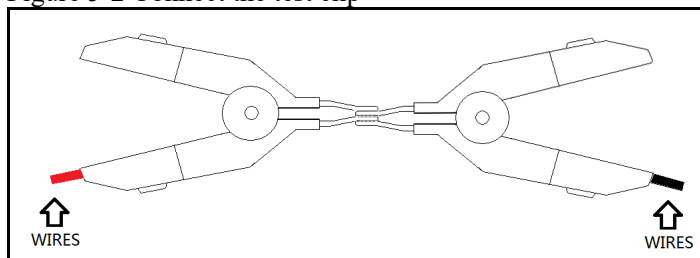

### 5.3 Comparator Mode [R-COMP],[V-COMP]

SCPI Command: `COMP:RMOD {OFF,ABS,PER,SEQ}`

SCPI Command: `COMP:VMOD {OFF,ABS,PER,SEQ}`

There are several items for choosing:

SEQ – Sequential Mode

PER – Percentage Mode [PER = (Result – Nominal) / Nominal \* 100%]

ABS – Absolute Mode [ABS = Result – Nominal]

■ Procedure to set comparator mode:

Step 1	Press [Setup] key to enter <SETUP> page	
Step 2	Use cursor key to select [RESMODE]	
Step 3	SEQ	Sequential Mode: Compare result with low and high limited values.
	PERΔ%	Percentage Mode: (Result – nominal) / nominal × 100%
	ABSΔ	Absolute Mode: Result – Nominal

#### 5.3.1 Comparator Nominal [R-NOMINAL],[V-NOMINAL]

SCPI Command: `COMPArator:TOLerence:RNOMinal <float>`

SCPI Command: `COMPArator:TOLerence:VNOMinal <float>`

When using the ABS and PER mode, the nominal value must be inputted.

The field is ignored when in SEQ mode.

The Nominal value must be positive.

■ Procedure to input nominal value:

Step 1	Press [Setup] key to enter <SETUP> page
Step 2	Use cursor key to select [R-NOMINAL] or [V-NOMINAL] field.
Step 3	Input the nominal value by numeric keypad.

#### 5.3.2 Limit [R-LOWER] [R-UPPER] [V-LOWER], [V-UPPER]

SCPI Command: `COMPArator:TOLerence:RLMT <lower>,<upper limit>`

SCPI Command: `COMPArator:TOLerence:VLMT <lower>,<upper limit>`



The high limited value should be greater than low nominal value.

When in SEQ Mode, please input the direct value of resistance or voltage.

When in ABS Mode, please input the absolute value of resistance or voltage.

When in PER % Mode, please input the relative value of resistance or voltage in %.

■ Procedure to input high/low limited values:

Step 1	Press [Setup] key to enter < SETUP > page
Step 2	Use cursor keys to select : [R-LOWER] [R-UPPER] or [V-LOWER] [V-UPPER] field
Step 3	Please input the percentage value when in [PER %] mode Please input the Direct value when in ABS and SEQ mode.

## 6. <SYSTEM CONFIG> page



This chapter describes:

- SYSTEM CONFIG
- SYSTEM INFORMATION
- SYSTEM SERVICE

### 6.1 <SYSTEM CONFIG> page

Press [SYSTEM] bottom soft-key to enter <SYSTEM CONFIG> page.

- LANGUAGE – Choose English or Chinese Language
- DATE/TIME
- ACCOUNT
- BEEP Feature
- BAUD – RS232/RS485 Communication Baud Rate.
- RS-485 Address
- SHAKE HAND – RS232/RS485 Shake Hand
- RESULT SEND – Acquire the test result by FETCH? Command or auto send.

All settings in <SYSTEM CONFIG> will be saved into internal flash disk automatically.

Figure 6-1 <SYSTEM CONFIG> page



#### 6.1.1 [LANGUAGE]

- Procedure to change language:

Step 1	Press [Meas] or [Setup] key to enter main page	
Step 2	Press bottom soft-key [SYSTEM] to enter <SYSTEM CONFIG>	
Step 3	Use cursor keys to select [Language] field	
Step 4	中文 [CHN]	Chinese

ENGLISH
---------

### 6.1.2 [ACCOUNT], [PASSWORD]

- ADMIN – All settings are available and can be saved.
- USER – All settings are available but **cannot** be saved.

■ Procedure to set up account:

Step 1	Press [Meas] or [Setup] key to enter main page	
Step 2	Press bottom soft-key [SYSTEM] to enter <SYSTEM CONFIG> page	
Step 3	Use cursor key to select [ACCOUNT] field	
Step 4	ADMIN	Administrator
	USER	

■ Procedure to setting password:

Step 1	Press [Meas] or [Setup] key to enter main page	
Step 2	Press bottom soft key [SYSTEM] to enter <SYSTEM CONFIG>	
Step 3	Use cursor key to select [PASSWORD] field	
	CHANGE PASSWORD	No more than 9 digits and only digits and letters can be input. Contact us if you forget password.
	DELETE PASSWORD	

### 6.1.3 [DATE], [TIME]

The instrument uses a 24-hour time.

■ Procedure to setting data :

Step 1	Press [Meas] or [Setup] key to enter main page	
Step 2	Press bottom soft key [SYSTEM] to enter <SYSTEM CONFIG> page	
Step 3	Use cursor keys to select [DATE] field	
Step 4	YEAR INCR+	
	YEAR DECR-	
	MONTH INCR+	
	DAY+	
	DAY-	

■ Procedure to setting time:

Step 1	Press [Meas] or [Setup] key to enter main page	
Step 2	Press bottom soft key [SYSTEM] to enter <SYSTEM CONFIG> page	
Step 3	Use cursor keys to select [TIME] field	
Step 4	HOUR INCR+	
	HOUR DECR-	
	MINUTE DECR+	
	MINUTE DECR-	
	SECOND INCR+	
	SECOND DECR-	

### 6.1.4 RS232 [BAUD] rate

Before you can control the AT526/AT526B by issuing RS-232 commands from built-in RS-232 controller connected via its DB-9 connector, you have to configure the RS-232 baud rate.

The AT526's/AT526B's built-in RS-232 interface uses the SCPI language.  
The configuration of RS-232

The keypad will be locked when the commutation established.  
Use SCPI language in Mini-USB programming.

RS-232 configuration is as follows:

- Data bits: 8
- Stop bits: 1
- Parity: none

■ Procedure to set baud rate:

Step 1	Press [SYSTEM] bottom soft-key to enter <SYSTEM CONFIG> page	
Step 2	Use cursor to select [BAUD] field	
Step 3	1200	For communication converter with opt coupler isolation
	9600	
	38400	
	57600	
	115200	Best for communication with PC

### 6.1.5 RS-232 Shake Hand [SHAKE HAND]

AT526/AT526B supports software “shake hand”. AT526/AT526B will return the whole command to host and then response the command when the [SHAKE HAND] is turned ON.

■ Procedure to turn ON the “Shake Hand”:

- Step 1. Press the [Meas] or [Setup] key
- Step 2. Press the [SYSTEM] bottom soft-key.
- Step 3. Use the cursor key to select [SHAKE HAND] field
- Step 4. Use the soft keys to turn ON.

ON	
OFF	

---

**NOTE:** If you use Applent Software, please make sure that the [SHAKE HAND] was turned OFF.

---

### 6.1.6 RS-232 Result Send Mode [RESULT SEND]

SCPI Command: **SYSTem:SENDmode {FETCH,AUTO}**

When you set the [RESULT SEND] to AUTO, the test result will be sent to host every end of measurement instead of by sending “FETCH?” command.

The format is:

+3.549568e-01,+3.827993e+00,RV GD  
 +3.549911e-01,+3.827931e+00,RV GD  
 +1.000000e+20,+1.000000e+20,RV NG

...

Where,

“+1.000000e+20” stands for overload or open.

“RV GD” stands for Resistance and Voltage are Good (GD).

“RV NG” stands for Resistance and Voltage are Not Good (NG) or invalid

■ Procedure to set up the result send mode:

- Step 1. Press the [Meas] or [Setup] key
- Step 2. Press the [SYSTEM] bottom soft-key.
- Step 3. Use the cursor key to select [RESULT SEND] field
- Step 4. Use the soft keys to turn ON.

FETCH	Acquire the test result by sending “FETCH?” command only.
AUTO	AT526/AT526B return the result every EOM

## 6.2 <SYSTEM INFORMATION>

There is no configurable option in the <SYSTEM INFO> page.

Figure 6-2 <SYSTEM INFORMATION>page

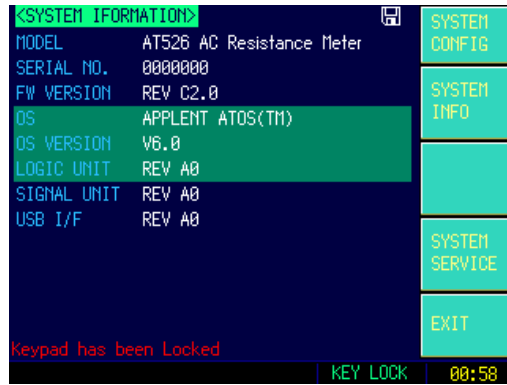

■ Procedure to view system information:

Step 1	Press [Meas] or [Setup] key to enter main page
Step 2	Press bottom soft key [SYSTEM] to enter <SYSTEM CONFIG>
Step 3	Press soft-key [SYSTEM INFORMATION] to enter <SYSTEM INFORMATION> page



6.3 <SYSTEM SERVICE> page



**Warning:**

Not available for users

Any unprofessional person is not allowed to have access to this page.

7. Handler Interface (Optional for AT526B)

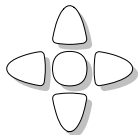

This chapter provides information of AT526’s built-in handler interface. Include:

- Pin Assignment
- Circuit Diagram
- Timing Chart

The AT526’s built-in handler interface outputs signals that indicate the end of a measurement cycle, the result of bin sorting by the comparator. In addition, the instrument accepts input of external trigger. You can use these signals to easily integrate the AT526 with a component handler or system controller. This means that you can fully automate such tasks as component inspection, component sorting, and processing of quality management data for higher manufacturing efficiency.

7.1 Pin Assignment

Figure 7-1

Pin Assignment

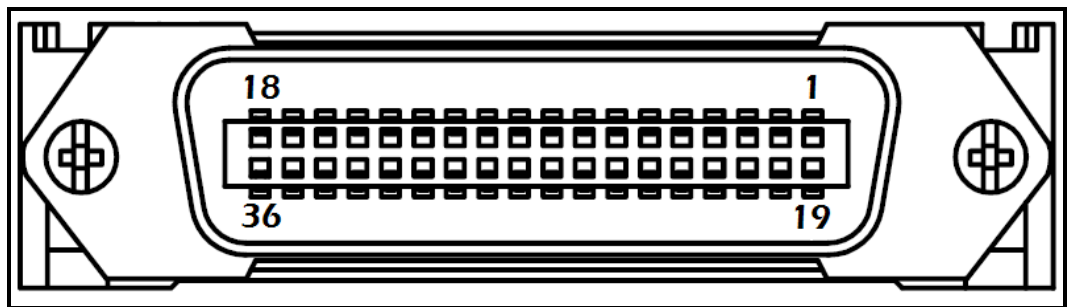

Table 7-1

Description of Handler Interface Signals

Pin	Signal	Direction	Overview
25	/R-LO	Output	0:LO
24	/R-NG	Output	0:NG
23	/R-HI	Output	0:HI
22	/V-LO	Output	0:LO
21	/V-NG	Output	0:NG
20	/V-HI	Output	0:HI
19	/OPEN	Output	0:OPEN-CIRCUIT
7	/EOC	Output	“End of measurement cycle” signal.

			When this signal is output, the measurement data and sorting results are available.
5	/RV-NG	Output	0: R or V NG
18	Trigger	Input	Rising-Edge, 5V~24V
27-30	GND	Power	GND Common signal of internal VCC and external VCC
33-34	Internal VCC	Power	Internal VCC (5VDC 1A)
35-36	External VCC	Power	External VCC (3.3V~35V)

## 7.2 Power Rating

	Input/output device	Logic	Electrical requirements
OUTPUT	Corrector out with pull-up resistance	Negative logic	35VDC 50mADC max
INPUT		Rising-edge	50mADC max
EXT.DCV	DC voltage input		35VDC max
INT.DCV	Built-in VCC		5VDC, 1A max

## 7.3 Electrical Characteristics

### 7.3.1 Input Signal:

Each input signal is connected to the LED (cathode side) of the photo-coupler. The LED (anode side) is connected to the pull-up power supply voltage.

### 7.3.2 Output Signal:

Each output signal is outputted via a pull-up 5k $\Omega$  (0.1W) resistor by using Darlington Transistor to provide high-current and high-voltage level translation.

### 7.3.3 Power supply

The power supply for the judgment output signal pull-up and that for the operation output signal pull-up and input signal drive can be set separately. You can select from +3.3V to +35V external power supply.

An internal VCC (5V DC) has been supplied for testing purpose.

To use the internal power, please connect PIN-34 and PIN-35 together.

### 7.3.4 Schematic

Figure 7-2

Typical Circuit Diagram of Handler Interface Input signals.

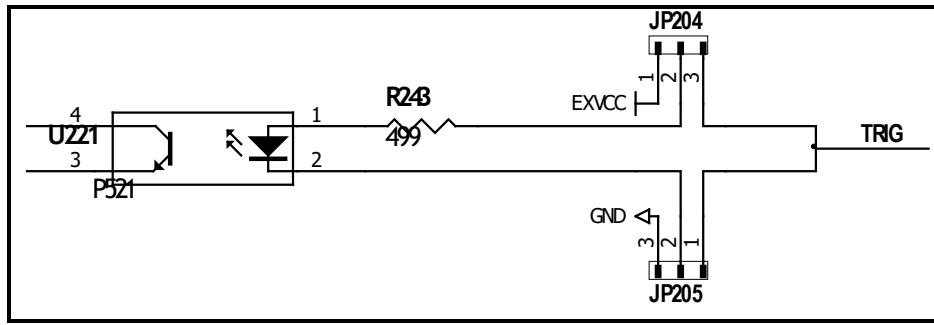
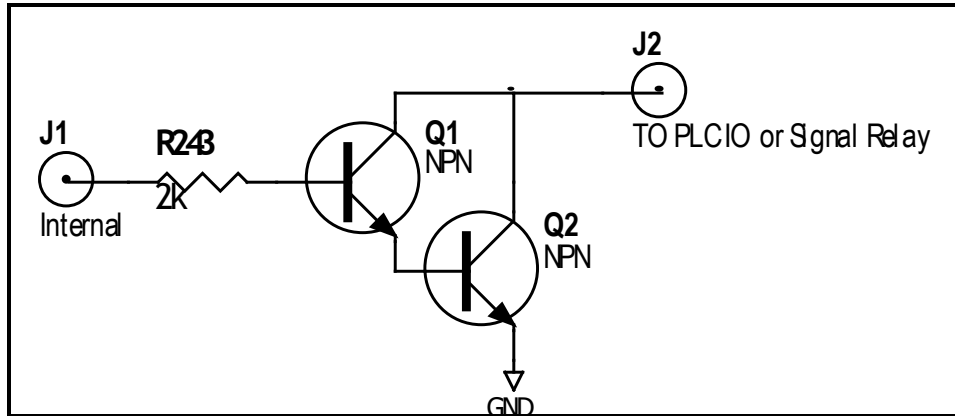

Figure 7-3

Typical Circuit Diagram of Handler Interface Output signals.



## 8. Remote Control



This chapter provides the following information to remotely control the AT526/AT526B via the RS-232C or USB interface.

- About RS-232C
- About USB Interface
- Select Baud Rate.
- About SCPI

AT526/AT526B can use the RS-232 interface or USB interface to communicate with the computer to complete all the instrument functions.

### 8.1 About RS-232C

You can connect a controller (i.e. PC and PLC) to the RS-232 interface by using Applent RS-232 DB-9 cable. The serial port uses the transmit (TXD), receive (RXD) and signal ground (GND) lines of the RS-232 standard. It does not use the hardware handshaking lines CTS and RTS.



NOTE:

JUST ONLY Use an Applent (not null modem) DB-9 cable.

Cable length should not exceed 2m.

Figure 8-1

The RS-232 connector in the rear panel

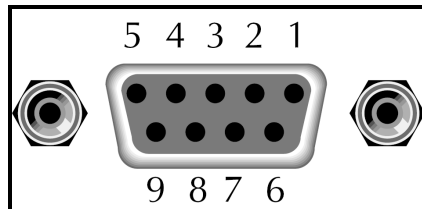

Table 8-1

RS-232 connector pinout

NAME	DB-25	DB-9	NOTE
DCD	8	1	Not Connection
RXD	3	2	Transmit data
TXD	2	3	Receive date
DTR	20	4	Not Connection
GND	7	5	Ground
DSR	6	6	Not Connection
RTS	4	7	Not Connection
CTS	5	8	Not Connection

- Make sure the controller you connect to AT526/AT526B also uses these settings.

The RS-232 interface transfers data using:

8 data bits,

1 stop bit,

And no parity.

## 8.2 About USB-Serial Interface (Option)

The USB-Serial Interface allows you to connect AT526/AT526B to a USB port on your PC.



NOTE:

Please install the USB-Serial driver before using USB-Serial Interface.

The Applent USB-Serial interface model is ATN2.

Figure 8-2

USB-Serial Interface ATN2



## 8.3 To Select Baud Rate

Before you can control the AT526/AT526B by issuing RS-232 commands from built-in RS-232 controller connected via its DB-9 connector, you have to configure the RS-232 baud rate.

The AT526's/AT526B's built-in RS-232 interface uses the SCPI language.

The configuration of RS-232

RS-232 configuration is as follows:

Data bits: 8-bit

Stop bits: 1-bit

Parity: none

### To set up the baud rate

- Step 1. Press the [Meas] or [Setup] key
- Step 2. Press the [SYSTEM] bottom soft-key.
- Step 3. Use the cursor key to select [BAUD] field
- Step 4. Use the soft keys to select baud rate.

Soft key	Function
1200	
9600	
38400	
57600	
115200	Recommend

## 8.4 SCPI Language

Standard Commands for Programmable Instruments (SCPI) is fully supported by the RS-232 interfaces.

---



NOTE:  
AT526/AT526B ONLY supports the SCPI Language.

---

## 9. Command Reference

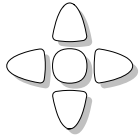

This chapter contains reference information on programming AT526/AT526B with the SCPI commands.

This chapter provides descriptions of all the AT526's/AT526B's available RS-232 commands which correspond to Standard Commands for Programmable Instruments (SCPI) command sets, listed in functional subsystem order.

### 9.1 Terminator

`<NL>` : The EOI line is asserted by New Line or ASCII Line Feed character (decimal 10, Hex 0x0A , or ASCII '\n')

### 9.2 Notation Conventions and Definitions

The following conventions and definitions are used in this chapter to describe RS-232 operation.

`< >` Angular brackets enclose words or characters that are used to symbolize a program code parameter or an RS-232 command.

`[ ]` A square bracket indicates that the enclosed items are optional.

`\n` Command Terminator

### 9.3 Command Structure

The AT526/AT526B commands are divided into two types: Common commands and SCPI commands.

The common commands are defined in IEEE std. 488.2-1987, and these commands are common for all devices. The SCPI commands are used to control all of the AT526's/AT526B's functions.

The SCPI commands are tree structured three levels deep. The highest level commands are called the subsystem commands in this manual. So the lower level commands are legal only when the subsystem commands have been selected.

A colon (:) is used to separate the higher level commands and the lower level commands.

Semicolon (;) A semicolon does not change the current path but separates two commands in the same message.

Command Tree Example

Figure 9-1

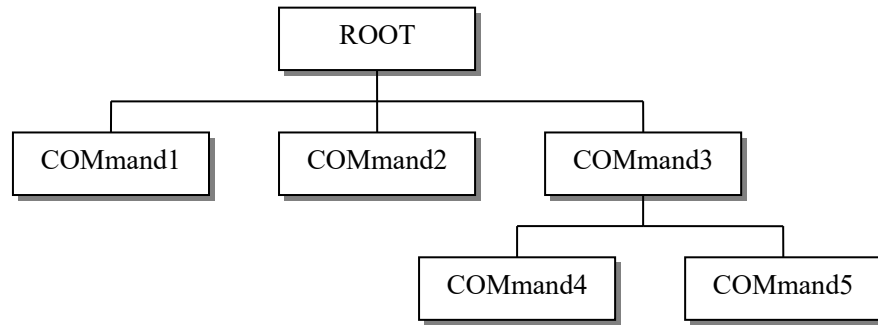

*Example:*

```

ROOT:COMmand3:COMmand5 ppp
ROOT Subsystem Command
  COMmand3 Level 2
    COMmand5 Level 3
      ppp Parameter
    
```

- The basic rules of the command tree are as follows.
  - Letter case (upper and lower) is ignored.  
For example,  
**ROOT:COMMAND3 = root:command3**
  - Spaces ( \_ used to indicate a space) must not be placed before and/or after the colon (:).  
For example,  
 **root \_ :\_ command3** →  **root:command3**
  - The command can be completely spelled out or in abbreviated.(The rules for command abbreviation are described later in this section)  
For example,  
**root:command3 = root:com3**
  - The command header should be followed by a question mark (?) to generate a query for that command.  
For example,  
**root:com3?**
    - The semicolon (;) can be used as a separator to execute multiple commands on a single line. The multiple command rules are as follows.  
Commands at the same level and in the same subsystem command group can be separated by a semicolon (;) on a multiple command line.  
For example,  
**root:com3:com5 ppp;com4 ppp**  
To restart commands from the highest level, a semicolon (;) must be used as the separator, and then a leading colon (:), which shows that the restarted command is a command at the top of the command tree, must follow.  
For example,  
**root:com3:com5 ppp;[:root:com1 ppp**



The AT526/AT526B accepts the three forms of the same SCPI commands: all upper case, all lower case, and mixed upper and lower case.

## 9.4 Header and Parameters

The commands consist of a command header and parameters. (See the following.)

*For example*

```

comp:nom 100.0e3
Header Parameter
    
```

- Headers can be of the long form or the short form. The long form allows easier understanding of the program code and the short form allows more efficient use of the computer.



- Parameters may be of two types as follows.
  - (A) Character Data and String Data Character data consists of ASCII characters. The abbreviation rules are the same as the rules for command headers.
  - (B) Numeric Data
    - (a) <integer>: For example, 1,+123,-123
    - (b) <float>: For example, 1.23e3, 5.67e-3, 123k, 1.23M, 2.34G, 1.234
    - (c) <scifloat>: For example, +1.23456e+03

The available range for numeric data is 9.9E37. When numeric data is used as a parameter, the suffix multiplier mnemonics and suffix units (The suffix multiplier must be used with the suffix unit) can be used for some commands as follows.

Table 9-1

Multiplier Mnemonics

Definition	Mnemonic
1E18 (EXA)	EX
1E15 (PETA)	PE
1E12 (TERA)	T
1E9 (GIGA)	G
1E6 (MEGA)	MA
1E3 (KILO)	K
1E-3 (MILLI)	M
1E-6 (MICRO)	U
1E-9 (NANO)	N
1E-12 (PICO)	P
1E-15 (PEMTO)	F
1E-18 (ATTO)	A

## 9.5 Command Reference

All commands in this reference are fully explained and listed in the following functional command order.

- DISPlay Subsystem
- FUNCTion Subsystem
- FETCh Subsystem
- COMParator Subsystem
- CORRection Subsystem
- TRIGger Subsystem
- ERRor Subsystem
- Common Command:
  - IDN?
  - SAV
  - TRG

## 9.6 DISPlay Subsystem

The DISP Subsystem command group sets the display page.

Figure 9-2

DISP Command Tree

DISPlay	:PAGE	{MEASurement, SETUp, COMParator, SYSTem, SYSTEMINFO (SINF) }
	:LINE	<string>

### 9.6.1 DISP:PAGE

The :PAGE command sets the display page.

The :PAGE? Query returns the abbreviated page name currently displayed on the LCD screen.

Command Syntax	DISP:PAGE <page name>
Parameter	Where, <page name> is: MEASurement [or MEAS] Sets display page to MEAS DISPLAY

	SETUP [or SETU]                      Sets display page to SETUP
	SYSTem [or SYST]                      Sets display page to SYSTEM CONFIG
	SYSTEMINFO [or SINF]                Sets display page to SYSTEM INFORMATION
<b>Example</b>	<b>SEND&gt; DISP:PAGE SYST&lt;NL&gt; //Set to the SYSEMT CONFIG</b>
<b>Query Syntax</b>	<b>DISP:PAGE?</b>
<b>Query Response</b>	<b>&lt;page name&gt;</b>
<b>Example</b>	<b>SEND&gt; DISP:PAGE?&lt;NL&gt;</b> <b>RET&gt; SYST&lt;NL&gt;</b>

**9.6.2 DISP:LINE**

The :LINE command enters an arbitrary comment line of up to 30 ASCII characters in the comment field.

<b>Command Syntax</b>	<b>DISP:LINE "&lt;string&gt;"</b>
<b>Parameter</b>	Where, <string> is ASCII character string (30 ASCII characters)
<b>Example</b>	<b>SEND&gt; DISP:LINE "This is a comment."&lt;NL&gt;</b>

**9.7 FUNCTION Subsystem**

The FUNCtion subsystem command group sets the measurement function, the measurement range, monitors parameter control.

Figure 9-3

FUNCTION Subsystem Tree

<b>FUNCtion</b>	<b>:RANGE</b>	{#Range Number , max , min}
	<b>:MODE</b>	{AUTO , HOLD , NOMinal}
	<b>:RATE</b>	{SLOW , MED , FAST , ULTRA}

**9.7.1 FUNCTION:RANGE**

The FUNCtion:RANGe command sets the range.

<b>Command Syntax</b>	<b>FUNC:RANGe &lt;0-4 , MIN , MAX&gt;</b>
<b>Parameter</b>	Where, <0-4 , MIN , MAX> is: 0-4, The range number MIN, =Range 0 MAX, =Range 4
<b>Example</b>	<b>SEND&gt; FUNC:RANG 2&lt;NL&gt; //Set range to [2] 300mΩ</b>
<b>Query Syntax</b>	<b>FUNC:RANGe?</b>
<b>Query Response</b>	<b>&lt;0-4&gt;&lt;NL&gt;</b>
<b>Example</b>	<b>SEND&gt; FUNC:RANG?&lt;NL&gt;</b> <b>RET&gt; 0&lt;NL&gt;</b>

**9.7.2 FUNCTION:RANGe:MODE**

The FUNCtion:RANGe:MODE command sets the range mode.

<b>Command Syntax</b>	<b>FUNCtion:RANGe:MODE {HOLD , AUTO , NOMinal}</b>
<b>Parameter</b>	Where, {HOLD , AUTO , NOMinal} is: HOLD:        Sets the auto range to off. AUTO:        Sets the auto range to on. NOMinal:    Sets the range mode to nominal.
<b>Example</b>	<b>SEND&gt; FUNC:RANG:MODE AUTO&lt;NL&gt; //Sets to auto range.</b>
<b>Query Syntax</b>	<b>FUNC:RANGe:AUTO?</b>
<b>Query Response</b>	<b>{HOLD , AUTO , NOM}</b>
<b>Example</b>	<b>SEND&gt; FUNC:RANG:MODE?&lt;NL&gt;</b> <b>RET&gt; auto&lt;NL&gt;</b>

**9.7.3 FUNCTION:RATE**

The FUNCtion:RATE command sets the test speed.

<b>Command Syntax</b>	<b>FUNCtion:RATE {SLOW , MED , FAST , ULTRA , ULTRaNodisp (ULTN) }</b>
<b>Example</b>	<b>SEND&gt; FUNC:RATE FAST&lt;NL&gt; //Sets to FAST Speed</b>
<b>Query Syntax</b>	<b>FUNC:RATE?</b>
<b>Query Response</b>	<b>{SLOW , MED , FAST , ULTR , ULTN}</b>
<b>Example</b>	<b>SEND&gt; FUNC:RATE?&lt;NL&gt;</b>

```
RET> ULTR<NL>
```

## 9.8 COMParator Subsystem

The COMParator subsystem command group sets the comparator function, including its ON/OFF setting, limit mode, and limit values.

Figure 9-4

COMParator Subsystem Command Tree

COMParator	:BEEP	{OFF, GD, NG}	
	:RMODe	{OFF, SEQ, PER, ABS}	
	:VMODe	{OFF, SEQ, PER, ABS}	
	:TOLerance	RNOminal	<float>
		VNOminal	<float>
		RLIMIT (RLMT)	<LOWER, UPPER>
		VLIMIT (VLMT)	<LOWER, UPPER>

### 9.8.1 COMParator:RMODe

The :COMParator:RMODe command sets resistance limit mode of the comparator function.

Command Syntax	COMParator:RMODe {OFF, ABS, PER, SEQ}
Parameter	Where, {OFF, ABS, PER, SEQ} is: ABS Absolute tolerance mode PER Percent tolerance mode SEQ Sequential mode
Example	SEND> COMP:RMODe PER<NL>
Query Syntax	COMParator:RMODe?
Query Response	{off, abs, per, seq}
Example	SEND> COMP:RMODe?<NL> RET> abs<NL>

### 9.8.2 COMParator:VMODe

The :COMParator:VMODe command sets voltage limit mode of the comparator function.

Command Syntax	COMParator:VMODe {OFF, ABS, PER, SEQ}
Parameter	Where, {OFF, ABS, PER, SEQ} is: ABS Absolute tolerance mode PER Percent tolerance mode SEQ Sequential mode
Example	SEND> COMP:VMODe PER<NL>
Query Syntax	COMParator:VMODe?
Query Response	{off, abs, per, seq}
Example	SEND> COMP:VMODe?<NL> RET> abs<NL>

### 9.8.3 COMParator:BEEP

COMP:BEEP sets the beep feature.

Command Syntax	COMParator:BEEP <OFF, GD, NG>
Example	SEND> COMP:BEEP GD<NL> SEND> COMP:BEEP OFF<NL>
Query Syntax	COMParator:BEEP?
Query Response	<OFF, GD, NG>
Example	SEND> COMP:BEEP?<NL> RET> OFF<NL>

### 9.8.4 COMParator:TOLerance:RNOminal

The COMParator:TOLerance:RNOminal command sets resistance nominal value for the tolerance mode of the comparator function.

Command Syntax	COMParator:TOLerance:RNOminal <float>
Example	SEND> COMP:TOL:RNOM 100m<NL>

	SEND> COMP:TOL:RNOM 1E-6<NL>
Query Syntax	COMParator:TOLerence:RNOMinal?
Query Response	<scifloat>
Example	SEND> COMP:TOL:RNOM?<NL> RET> +1.00000e-03<NL>

### 9.8.5 COMParator:TOLerence:RLiMiT

The COMParator:TOLerence:RLiMiT command sets resistance lower/upper limit values.

Command Syntax	COMParator:TOLerence:RLiMiT <lower>,<upper limit>
Parameter	Where, <lower>, <upper> is: lower <float> lower limit value upper <float> upper limit value
Example	SEND> COMP:TOL:RLMT 100m,330m<NL>
Query Syntax	COMParator:TOL:RLMT? <n>
Query Response	<float: lower limit>,<float: upper limit>
Example	SEND> COMP:TOL:RLMT?<NL> RET> 1.000000e-01,3.300000e-01<NL>

### 9.8.6 COMParator:TOLerence:VNOMinal

The COMParator:TOLerence:VNOMinal command sets resistance nominal value for the tolerance mode of the comparator function.

Command Syntax	COMParator:TOLerence:RNOMinal <float>
Example	SEND> COMP:TOL:RNOM 100m<NL> SEND> COMP:TOL:RNOM 1E-6<NL>
Query Syntax	COMParator:TOLerence:RNOMinal?
Query Response	<scifloat>
Example	SEND> COMP:TOL:RNOM?<NL> RET> +1.00000e-03<NL>

### 9.8.7 COMParator:TOLerence:VLiMiT

The COMParator:TOLerence:VLiMiT command sets voltage lower/upper limit values.

Command Syntax	COMParator:TOLerence:VLiMiT <lower>,<upper limit>
Parameter	Where, <lower>, <upper> is: lower <float> lower limit value upper <float> upper limit value
Example	SEND> COMP:TOL:VLMT 1.1,3.9<NL>
Query Syntax	COMParator:TOL:VLMT? <n>
Query Response	<float: lower limit>,<float: upper limit>
Example	SEND> COMP:TOL:VLMT?<NL> RET> 1.100000e+00,3.900000e+00<NL>

## 9.9 TRIGger Subsystem

The TRIGger subsystem command group is used to enable a measurement and to set the trigger mode.

Figure 9-5

TRIGger Subsystem Command Tree

TRIGger	[ :IMMEDIATE]	
	:SOURCE	{ INT , MAN , EXT , BUS }
TRG		

### 9.9.1 TRIGger[:IMMEDIATE]

The TRIGger[:IMMEDIATE] command causes the trigger to execute one measurement under BUS trigger mode.

Command Syntax	TRIGger[:IMMEDIATE]
Example	SEND> TRIG<NL>
Note	This command can be ONLY used in BUS trigger mode.

### 9.9.2 TRIGger:SOURce

The TRIGger:SOURce command sets the trigger mode.

<b>Command Syntax</b>	<b>TRIGger:SOURce {INT,MAN,EXT,BUS}</b>
<b>Parameter</b>	Where, {INT,MAN,EXT,BUS} is INT Internal Trigger Mode MAN Manual Trigger Mode EXT External Trigger Mode BUS Remote Trigger Mode
<b>Example</b>	<b>SEND&gt; TRIG:SOUR BUS&lt;NL&gt;</b>
<b>Query Syntax</b>	<b>TRIGger:SOURce?</b>
<b>Query Response</b>	<b>{INT,MAN,EXT,BUS}</b>
<b>Example</b>	<b>SEND&gt; TRIG:SOUR? 1&lt;NL&gt;</b> <b>RET&gt; INT&lt;NL&gt;</b>

### 9.9.3 TRG

The TRG command (trigger command) performs the same function as the Group Execute Trigger command but return the test result.

<b>Command Syntax</b>	<b>TRG</b>
<b>Query Response</b>	<b>&lt;primary value&gt;,&lt;comparator result&gt;</b>
<b>Example</b>	<b>SEND&gt; TRG</b> <b>RET&gt;</b> <b>+3.514007e-01,+3.827861e+00,RV GD</b> <b>+1.000000e+20,+1.000000e+20,RV NG //OPEN or OVERLOAD</b>
<b>Note</b>	This command can be used ONLY in BUS trigger mode.

## 9.10 FETCh Subsystem

The FETCh subsystem command group is a sensor-only command which retrieves the measurement data taken by measurement(s) initiated by a trigger, and places the data into the output buffer.

Figure 9-6

FETCh Subsystem Command Tree

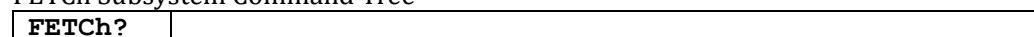

### 9.10.1 FETCh?

The FETCh? retrieves the latest measurement data and comparator result.

<b>Query Syntax</b>	<b>FETCh?</b>
<b>Query Response</b>	<b>&lt;float&gt;,&lt;comparator result&gt;</b>
<b>Example</b>	<b>SEND&gt; FETC?&lt;NL&gt;</b> <b>RET&gt; +3.506759e-01,+3.827991e+00,RV GD&lt;NL&gt;</b>

## 9.11 CORRection Subsystem

The CORRection subsystem command group to execute the short circuit clear zero correction function.

Figure 9-7

CORRection Subsystem Command Tree

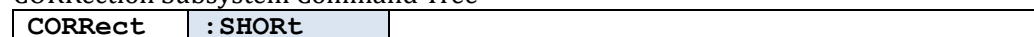

### 9.11.1 CORRection:SHORT

The CORRection:SHORT command execute the short-circuit clear zero for all ranges.

<b>Command Syntax</b>	<b>CORRection:SHORT</b>
<b>Example</b>	<b>SEND&gt; CORRection:SHOR&lt;NL&gt;</b> <b>RET&gt; Short Clear Zero Start. &lt;NL&gt;</b> <b>RET&gt; PASS&lt;NL&gt;</b>
<b>Note</b>	<b>Before sending this command, please short-circuit the terminals.</b>

## 9.12 SYSTEM subsystem

Figure 9-8 SYSTEM command tree

<b>SYSTEM</b>	<b>:SENDmode</b>	<b>{FETCH,AUTO}</b>
---------------	------------------	---------------------

### 9.12.1 SYSTEM:SENDmode

SYST:SEND command sets the RS-232 Result Send Mode.  
Please refer to Page.23 [Section 0](#)

**NOTE:** If you use Applent Software, please make sure that the [SHAKE HAND] was turned OFF.

RS-232 Result Send Mode [RESULT SEND]

<b>Command Syntax</b>	<b>SYSTe m:SENDmode {FETCH,AUTO}</b>
<b>Example</b>	<b>SEND&gt; SYST:SEND AUTO&lt;NL&gt;</b>
<b>Query Syntax</b>	<b>SYST:SEND?</b>
<b>Query Response</b>	<b>&lt;FETCH,AUTO &gt;</b>

## 9.13 ERROR Subsystem

The ERRor subsystem retrieves last error information.

<b>Query Syntax</b>	<b>ERRor?</b>
<b>Query Response</b>	<b>Error string</b>
<b>Example</b>	<b>SEND&gt; ERR?&lt;NL&gt; RET&gt; no error.&lt;NL&gt;</b>

## 9.14 IDN?

The \*IDN? query returns to the instrument ID.

<b>Query Syntax</b>	<b>IDN? Or *IDN?</b>
<b>Query Response</b>	<b>&lt;MODEL&gt;,&lt;Revision&gt;,&lt;SN&gt;,&lt;Manufacturer&gt;</b>

## 9.15 SAV

The SAV command will save all changed settings into internal flash disk.

<b>Query Syntax</b>	<b>SAV</b>
<b>Query Response</b>	<b>OK</b>

# 10. Specification



This chapter describes:

- Basic Specifications
- Dimensions

## 10.1 General Specifications

Accuracy is defined as meeting all of the following conditions.

- Temperature:  $23^{\circ}\text{C} \pm 5^{\circ}\text{C}$
- Humidity:  $<65\%$  R.H.
- Correction: Short-circuit Clear Zero
- Warming Time:  $>60\text{min}$
- Adjustment Time: 12months

Working Environment:

- Nominal: Temperature  $15^{\circ}\text{C} \sim 35^{\circ}\text{C}$  Humidity  $<80\%$  RH
- Working: Temperature  $10^{\circ}\text{C} \sim 40^{\circ}\text{C}$  Humidity  $10 \sim 90\%$  RH
- Storage: Temperature  $0^{\circ}\text{C} \sim 50^{\circ}\text{C}$  Humidity  $10 \sim 90\%$  RH

## 10.2 About Accuracy

Accuracy is calculated from the reading error ( $\pm\%$  rdg.) determined by the measurement value and range, and the digit error ( $\pm$  dgt.).

Calculation Example:

Measurement value:  $1\ \Omega$ , Measurement range:  $3\ \Omega$

Specified accuracy (from table below):  $\pm 0.5\%$  rdg.,  $\pm 5$  dgt.

(A) Reading error ( $\pm\%$  rdg.):  $1\ [\Omega] \times 0.5\% = \pm 0.005\ [\Omega]$

(B) Digit error ( $\pm$  dgt.):  $\pm 5$  dgt. =  $\pm 0.0005\ [\Omega]$  (at  $0.0001\ \Omega$  resolution)

(C) Total error (A + B):  $\pm 0.0055\ [\Omega]$

Applying total error (C) to the measurement value of  $1\ \Omega$  gives an error limit of  $0.9945$  to  $1.0055\ \Omega$ .

### 10.3 AC Resistance Range for AT526

RANGE		Max Reading	Resolution	ULTRA	FAST	MED	SLOW	Test Current
1	30mΩ	33.000mΩ	1μΩ	0.5% ± 20	0.3% ± 10	0.2% ± 10	0.2% ± 5	150mA
2	300mΩ	330.00mΩ	10μΩ	0.5% ± 20	0.3% ± 10	0.2% ± 10	0.2% ± 5	15mA
3	3Ω	3.3000Ω	100μΩ	0.5% ± 20	0.3% ± 10	0.2% ± 10	0.2% ± 5	1.5mA
4	30Ω	33.000Ω	1mΩ	0.5% ± 20	0.3% ± 10	0.2% ± 10	0.2% ± 5	150μA
5	300Ω	330.00Ω	10mΩ	0.5% ± 20	0.3% ± 10	0.2% ± 10	0.2% ± 5	15μA
6	3kΩ	3.3000kΩ	100mΩ	0.5% ± 20	0.5% ± 10	0.2% ± 10	0.2% ± 5	15μA
7	30kΩ	33.000kΩ	1Ω	0.8% ± 50	0.5% ± 20	0.2% ± 20	0.2% ± 10	1.5μA

### 10.4 AC Resistance Range for AT526B

RANGE		Max Reading	Resolution	ULTRA	FAST	MED	SLOW	Test Current
1	30mΩ	33.000mΩ	1μΩ	0.5% ± 20	0.3% ± 10	0.2% ± 10	0.2% ± 5	150mA
2	300mΩ	330.00mΩ	10μΩ	0.5% ± 20	0.3% ± 10	0.2% ± 10	0.2% ± 5	15mA
3	3Ω	3.3000Ω	100μΩ	0.5% ± 20	0.3% ± 10	0.2% ± 10	0.2% ± 5	1.5mA
4	30Ω	33.000Ω	1mΩ	0.5% ± 20	0.3% ± 10	0.2% ± 10	0.2% ± 5	150μA

### 10.5 DC Voltage Range for AT526

RANGE		Max Reading	Resolution	ULTRA	FAST	MED	SLOW
0	12V	12.0000V	10μV	0.5%±100	0.1%±50	0.05%±10	0.05%±5
1	120V	120.000V	100μV	0.5%±100	0.1%±50	0.05%±10	0.05%±5

### 10.6 DC Voltage Range for AT526B

RANGE		Max Reading	Resolution	FAST	MED	SLOW
0	12V	6.0000V	10μV	0.1%±50	0.05%±10	0.05%±5
1	60V	60.000V	100μV	0.1%±50	0.05%±10	0.05%±5

### 10.7 Features

Display: True color TFT-LCD, Size: 3.5"

Measurement Range for AT526: 0.001mΩ~33KΩ

Measurement Range for AT526B: 0.001mΩ~33Ω

Measurement Speed for AT526: **Range-hold** mode and comparator is ON:

SLOW: 1 times/sec (1s)

MED: 10 times/sec (100ms)



	FAST:	30 times/sec (33ms)
	ULTRA:	146 times/sec (6.8ms)
Measurement Speed for AT526B: <b>Range-hold</b> mode and comparator is ON:		
	SLOW:	1 times/sec (1s)
	MED:	10 times/sec (100ms)
	FAST:	30 times/sec (33ms)
Ranging:	AT526: Auto and Manual range with 7 Ranges; AT526B: Auto and Manual range with 4 Ranges	
Correction Function:	SHORT-CIRCUIT Clear Zero	
Terminals:	Four-terminal test method	
Comparator:	ABS, PER and SEQ sorting methods	
Handler:	Total 8 Bins, 3 bins Resistance HI/IN/LO, 3 bins Voltage HI/IN/LO, 1 bin OPEN-CIRCUIT, 1 bin RV NG	
Beep Feature:	OFF/GD/NG	
Trigger Mode:	Internal, Manual, BUS and External trigger.	
Built-in Interface:	Handler interface, RS232 interface	
Programming language:	SCPI	
Others:	Data hold function, Keypad lock	

## 10.8 Environment

Temperature and humidity range:	15°C~35°C, 80% RH or less
Storage temperature and humidity range:	10°C~40°C, 10~90% RH
Power Supply:	AC 110V/220V, 48.5Hz-62.5Hz
Fuse:	1A Slow-Blow
Maximum rated power:	15VA
Weight:	3.5kg, net

## 10.9 Dimensions

Figure 10-1 Dimensions

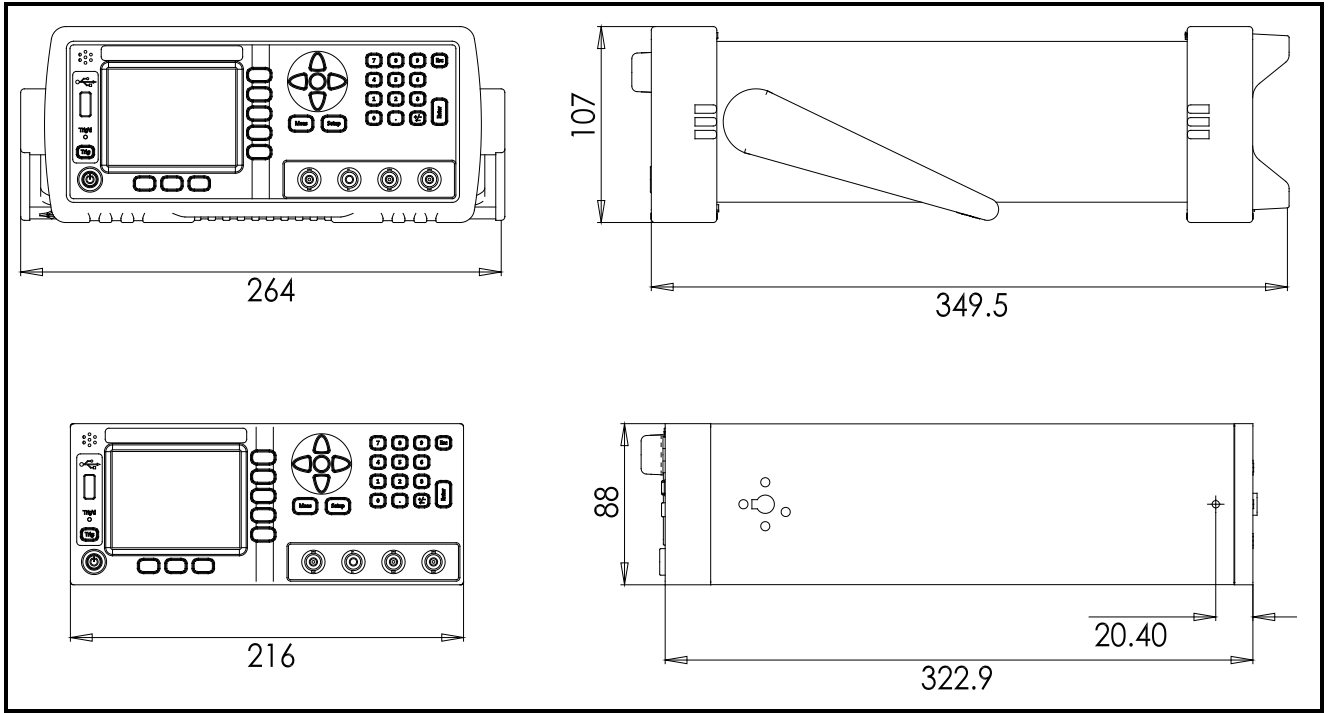

-AT526/AT526B User's Guide-  
English

©2005-2016 Applent Instruments Ltd.